

# Ophthalmic Nursing: Getting Started

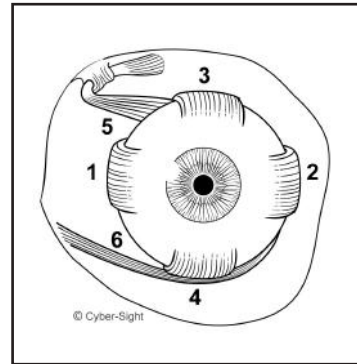
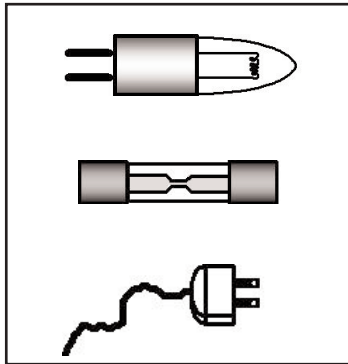

**Module 1: Caring for the Patient and Ourselves**

**Module 2: General Equipment Care**

**Module 3: A Nurses Guide to Basic Anatomy  
and Physiology of the Eye**



# Volume 1

# Ophthalmic Nursing: Getting Started

## **Module 1: Caring for the Patient and Ourselves**

Author: Heather Machin, RN

## **Module 2: General Equipment Care**

Authors: Heather Machin, RN and Ismael Cordero

## **Module 3: A Nurses Guide to Basic Anatomy and Physiology of the Eye**

Authors: Fiona O'Sullivan, RN; Heather Machin, RN; & Eugene Helveston, MD

*Contributor:* Jackie Newton, RN

*Produced by:* Lynda Smallwood

*Editorial Thanks:*

Dr. Eugene Helveston, Dr. Hunter Cherwek, and Prof. Janet Marsden

*Illustrations:* Sharon Teal © Cyber-Sight

Over the years, ophthalmic nursing has developed into its own sub-specialized field of nursing due to a rapid expansion of the technologies and the emergence of eye-only hospitals, day surgeries and clinics.

Through this advancement the nurse, physician and hospital administrator have had to adapt to perform and manage stand-alone eye-focused centers and develop services without the traditional support of larger hospital institutions.

Nurses are a key element to the success of these centers and their understanding and knowledge of the eye, eye-patient and the services in order to facilitate care to the patient, support both nurse and surgeon and provide financial management of the facility.

Orbis, who supports the World Health Organization's Vision2020 Initiative, is committed to encouraging nurses around the world to discover and contribute to eye care in their communities in order to improve services and support patients within their care.

This Volume is the first of many volumes designed to provide the back ground knowledge and skills that are required to work effectively as an ophthalmic nurse in this day-and-age. The nature of being an ophthalmic nurse includes knowledge of how to perform safely, an understanding of technology care and having a baseline understanding of the basics of ocular anatomy and physiology.

Future volumes will explore working in the peri-operative environment, clinic ophthalmic nursing, eye-diseases and so much more.

# TABLE OF CONTENTS

<b>Module 1: Caring for the Patient and Ourselves</b> .....	<b>1</b>
Patient Dignity, Their Rights and Respect .....	3
Patient Privacy and Security .....	4
Informed Consent .....	4
World Health Organization's Safe Site Surgery .....	5
Safe Site Surgery Tips from Around the World .....	6
Wrist Bands .....	6
Marking the Surgical Site .....	6
Patient Schedule .....	6
Personal Protective Equipment .....	8
Gloves .....	8
Glasses/Shields .....	8
Shoes .....	8
Masks .....	9
Manual Handling .....	9
Principles of Safe Manual Handling .....	10
Moving a Patient .....	10
Waste Management .....	12
Disposing of Fluids .....	14
Handling Sharp Items .....	14
Sharp Handling Tips from Around the World .....	15
Sharp Disposal Containers .....	15
Sharp Dish Containers .....	16
Linen Management .....	17
Patient Linen .....	17
Surgical Linen .....	17
Infection Control .....	17
Hand Hygiene .....	17
Staff Personal Hygiene .....	18
Patient Hygiene .....	18
Pre-Surgery Patient Wash .....	18
Food Handling .....	20
Hospital Cleaning .....	20
Daily .....	21
Weekly .....	21
Monthly .....	21
Third Monthly (quarterly) .....	21
Personal Cleaning Tip .....	21
Airflow Management .....	22
Workplace Health and Safety (WPHS) .....	22
Spills .....	22
Dangers .....	23
Fire and Evacuation .....	23
World Health Organization's (WHO) Safe Site Surgery Competency .....	25
Appendix A: Unit Conversion Table .....	26

<b>Module 2: General Equipment Care</b> .....	<b>29</b>
Safety First .....	31
Reporting Equipment Damage .....	31
What is the Biomedical Engineering Department? .....	32
What are the Electrician and Maintenance Departments? .....	32
Storage in Different Climates .....	33
Getting Equipment Ready: <i>The End User Test</i> .....	35
Using Electrical Equipment .....	35
Wall Sockets (power points/plugs) .....	35
What is an Electric Shock? .....	36
Water and Electricity Do Not Mix .....	36
Preventing Water-Electricity Mix and Harm .....	36
Managing Dangerous Situations Caused by Water-Electricity Mix .....	37
Power Boards - Over Use and Over Heating .....	37
Using Gas Cylinder Equipment .....	38
Storing Gas Cylinders .....	38
How to Tell if the Gas Cylinder Needs to be Changed .....	38
What Do You Do with an Empty Gas Cylinder? .....	39
Working with Gas Cylinder Wall Banks .....	39
Changing a Gas Cylinder .....	39
Tips for Setting up Gas Cylinders and Tubing .....	40
Using Battery Operated Equipment .....	40
Tips on Caring for Battery Equipment .....	40
Bulbs (Light Globes) .....	41
Prolonging Life of Bulbs .....	41
Removing and Installing Bulbs .....	41
Types of Bulbs .....	42
Fuses .....	42
Electrical Cords .....	43
Caring for Accessory Equipment .....	43
Cleaning .....	44
Before Cleaing .....	44
General Equipment Cleaning Between Patients .....	44
General Equipment Cleaning at the Beginning and End of the Day .....	44
Cleaning Lenses .....	44
Preventing Fungus Growth .....	44
Tips for Managing Your Equipment .....	45
<b>Module 3: A Nurses Guide to Basic Anatomy and Physiology of the Eye</b> .....	<b>47</b>
Bones: Orbit .....	49
Blinking and Protection: Eyelids .....	49
Tears: Lacrimal System .....	50
Movement: Extra-ocular Muscles .....	52
The Eye .....	52
The Conjunctiva .....	52
The Cornea .....	53
The Center and Front of Eye .....	54
The Uveal Tract .....	55
The Layers of the Eye: Sclera, Choroid and Retina, and Vitreous .....	56

## **Program Information**

Ophthalmic nursing encompasses many subspecialty nursing skills and areas of knowledge including clinical assessment and triage, pre-operative preparation, surgical intervention, anesthetics, post-operative recovery, instrument cleaning, medical treatment and evaluation, patient education and advocacy, and management.

Before we are able to function as a member of the ophthalmic nursing team, there are particular basic skills which, regardless of our sub-specialty, are important for ensuring effective patient care and for providing a safe work environment for ourselves and our fellow nursing and medical team members.

This module will provide you with the basics to function as a member of the ophthalmic nursing team. After this module you will then be ready to move onto other areas of your practice.

## **How to Use These Modules**

Orbis offers these modules as a free resource for your hospital and your own private learning.

## **Orbis Certificate of Completion**

Should you wish to earn continual professional development (study) acknowledgement and recognition from Orbis you must register and then submit the assessment and competency answers found throughout this module (activities, competency and quiz) and receive a grading of 60% or higher. Submit your answers to: **nursingeducation@orbis.org**. If you are not working with a local mentor, Orbis can provide you with the details and name of an Orbis Mentor who will assist you with enquires and assessment.

Should you successfully complete the assessment you will be eligible for a certificate of completion.

If you do not have regular access to a computer you may register via post (a registration form can be found at the end of this module). You may also post your work to your Mentor.

## **Time Frame for Completion**

If you decide you would like to receive certification of completion, you must submit all assessments within 4 months of your registration date. You may choose to submit one or two assessment items at a time or you may prefer to submit all assessments together. This is your choice; however, please be considerate about the time required for your Mentor to evaluate your assessment.

## Computer Access

While internet, emails and typed assessments are preferred, Orbis recognizes that access to computers and typewriters can be limited in some parts of the world. Therefore you are also welcome to hand-write your assessment and post it to your Mentor. Please write neatly.

Note: All assessment must be submitted in English unless previously discussed with your Mentor.

## Cyber-Sight®

Orbis's Cyber-Sight is an excellent free online resource for study, mentor support, and general ophthalmic information. Please go to [www.cybersight.org](http://www.cybersight.org).

## English as a Second Language

Orbis acknowledges that English may not be your first language. Therefore, as long as the content is understandable, you will not be assessed on your English sentence structure, spelling or grammar.

## Picture Clues

You will find the icons shown below throughout the Orbis Nursing module series. They are designed to assist your learning and provide you with prompts.



*Tips from Around the World*



*Recommended Readings*



*Competencies to be completed to receive a certificate*



*Assessment/Activities/Quiz to submit to receive a certificate*

# Module 1: Caring for the Patient and Ourselves ©

---

## Module Outline

This module will discuss:

- ◆ Patient Dignity, Their Rights and Respect
- ◆ Patient Privacy and Security
- ◆ Informed Consent
- ◆ World Health Organization's Safe Site Surgery
- ◆ Personal Protective Equipment
- ◆ Manual Handling (lifting and back care)
- ◆ Waste Management
- ◆ Disposal of Fluids
- ◆ Handling Sharp Items
- ◆ Linen Management
- ◆ Infection Control and Hand-Hygiene
- ◆ Hospital Cleaning
- ◆ Airflow Management
- ◆ Work Place Health and Safety
- ◆ Fire and Evacuation

This module will include a competency on:

- ◆ The World Health Organization's (WHO) Safe Site Surgery

## Module Objectives

1. Promote safe practice
2. Promote the World Health Organization's Safe Site Surgery campaign
3. Promote the World Health Organization's Hand Hygiene campaign
4. Provide safe practice knowledge and skills to ophthalmic nurses
5. Improve patient safety and surgical outcomes
6. Introduce students to alternative practice methods used around the world

For your WHO Safe Site Surgery Competency assessment, please discuss this with your mentor. In some instances one-on-one assessment could occur while at other times, a nurse educator can be assigned to assess you or you could have yourself filmed or photographed conducting the safe site check and accompany this with a step-by-step explanation of the process you are taking.

### **Module Grading**

Activity 1: 10%

Activity 3: 9%

Activity 5: 10%

Activity 7: 40%

Activity 2: 10%

Activity 4: 11%

Activity 6: 10%

*60% of grading, plus the completion of the competencies are required to pass this module.*

## **Patient Dignity, Their Rights and Respect**

The role of the ophthalmic nurse is to provide direct support and care to the ophthalmic patient and their family. This support includes the provision of medical services and treatment, education and advice regarding follow-up treatment and further prevention, and the opportunity to be involved in their care outcome through informed consent.

Patients have the right to refuse or question the medical or surgical treatment offered to them. They also have the right to seek information about their condition and further prognosis.

In most countries it is the doctor's role to provide this information to the patient and their family. The nurse is responsible for ensuring that the patient is comfortable and supported at all stages of their care and that they understand the process and procedures that are about to take place.

If the nurse discovers that a patient has not understood what the doctor has told them they have a duty of care to inform the doctor of the patient's concerns. In some instances it may be necessary for the nurse to educate the patient with information through recommended resources provided by the doctor.

*Note: If you are not familiar with the doctor's standing-orders then do not provide the patient with information as this may confuse the patient further. In this instance please ask a senior colleague to assist either yourself or the patient, and seek assistance from the doctor as soon as possible.*

The ophthalmic nurse is responsible for checking that the patient:

- ◆ Is familiar with their ocular and medical history and/or conditions
- ◆ Understands the medical or surgical treatment that is being offered
- ◆ Is comfortable with what is about to take place
- ◆ Has provided informed consent
- ◆ Has had their questions answered
- ◆ Has been provided with pre-operative information and post-operative outcome expectations

Note: It is the patient's right to refuse medical and surgical treatment even if the medical advice urges them to undergo the treatment.

Ophthalmic patients, regardless of their procedure, are entitled to dignity and respect from the ophthalmic nurse and medical team and at no stage should patients be forced to undergo medical or surgical treatment, take part in a procedure or process which goes against their cultural or spiritual belief.

Patients must also be informed of the process early in their care to ensure they are not frightened or distressed when a process occurs. For example, ladies wearing religious head wear should be informed during the initial consultation that the head dress may be removed before surgery so the surgeon can pre-wash the surgical site and place a sterile drape over the area.

## ***Patient Privacy and Security***

As health professionals, nurses have the responsibility to ensure the patient's privacy and security at all stages.

The nurse will not:

- ◆ Disclose patient details to anyone other than the patient and their designated guardian/family member, and the appointed medical team
- ◆ Leave the patient's chart in a public place. The chart is to be stored in a secure place at all times
- ◆ Discuss patient's private information outside of the clinical environment

The nurse, for security reasons, will ensure that:

- ◆ The patient is safe, comfortable and out of danger (e.g. they are not going to slip on water remaining on the floor)
- ◆ Medications and chemicals are stored in a safe place so they can not be reached by patients or visitors and accidentally administered
- ◆ Patient information is not divulged to non-guardian/family members.

## ***Informed Consent***

Informed consent is a process whereby the doctor (surgeon and/or anesthesiologist) provide a detailed outline of the proposed surgery to the patient and/or their guardian. This process includes information on:

- ◆ Diagnosis
- ◆ Non-surgical treatment options
- ◆ Surgical treatment options
- ◆ Reason for recommending surgical treatment
- ◆ What the treatment will achieve
- ◆ How the treatment will be delivered
- ◆ Expected length of time for treatment or surgery
- ◆ Possible future treatments
- ◆ Complications of surgery/medical treatment
- ◆ Prognosis if no treatment is chosen
- ◆ Statistics on success and complications, including fatality and infection rates
- ◆ Cost
- ◆ If this treatment is approved or remains in the research phase
- ◆ If the patient's care will be part of a clinical research trial
- ◆ Will photos of the surgery be taken
- ◆ Location of treatment and staff/medical students involved
- ◆ How the patient is to prepare for surgery

This information is shared at an initial patient meeting. Thereafter, the patient is asked to sign a consent form which will also outline the above. The patient or guardian's signature is to be witnessed by another person of legal age. The witness also signs the consent form.

The consent form is placed inside the patient's chart and a copy is also provided to the patient for their record. This consent form is then used by medical and nursing staff involved in the patient's care to ensure that they are treated and cared for according to their wishes.

## World Health Organization's Safe Site Surgery

The World Health Organization's (WHO) Safe Site Surgery Guidelines, developed by an international health care team, is designed to provide a starting point for safe surgery. These guidelines recommend checking the correct patient receives the correct treatment and surgery, to the correct part of the body, with the correct methods at the correct time. In order to do this, the WHO has developed a check list which is to be completed by all members of the medical team, including the surgeon and anesthetist. These checklists have now been incorporated into hospitals around the world.

WHO Safe Site Surgery checklist checks:

- ◆ Surgical team introduction to each other
- ◆ Correct patient and surgical site has been identified
- ◆ Signed, and correct consent form
- ◆ Required fasting, medications and doses, anesthetic options and skin-preparations correspond with standing orders and/or the doctor's documented request
- ◆ Prior to commencing surgery all members of the team, within a particular clinical area, have checked that the patient's details in the chart correspond with the patient in front of them and that they have all the required equipment, stock, medications and instruments required before commencing the procedure (the medication and stock must be in-date. No expired medications are to be used.)
- ◆ Any issues for each department have been raised, discussed and followed through as required
- ◆ The team will complete a three-stage check system which takes place. These are:
  1. Time In: Before or when entering the operating room and before anesthesia
  2. Time Out: Before the start of surgery and all parties in attendance
  3. Sign Out: At the end of surgery when the wound is just about to be closed



### Reading Activity 1

1. Please download a copy of the latest WHO Safe Site Surgery Guidelines, from the below WHO webpage, and read through.

<http://www.who.int/patientsafety/safesurgery/en/>

(This webpage also provides this in a variety of languages.)

2. Please download the ORBIS Safe Site Checklist from Cyber-Sight and review the *Time In*, *Time Out* and *Sign In* sections.

[http://www.cybersight.org/bins/content\\_page.asp?cid=1-10491](http://www.cybersight.org/bins/content_page.asp?cid=1-10491)

This checklist, which has been adapted from the original WHO checklist and developed by Moorfields Eye Hospital, London, UK, is designed specifically for the ophthalmic operating room.



## Safe Site Surgery Tips from Around the World

You will find below some examples of additional safety checks used by hospitals around the world to ensure safe site surgery.

### ***Wrist Bands***

Many countries place a water-proof wrist band onto a patient's arm. This band contains information such as name, date of birth, surgery type, telephone number, their hospital identity code number and the surgeon's name. All these details are identical to the details inside the patient's chart and are used to double check that the correct patient is matched to the correct chart containing the correct information about the patient.

By checking the wrist band, the team can reduce the chance of picking up the wrong chart for the patient and conducting the wrong surgery.

Depending on hospital policy, this band can be placed on the arm of the corresponding surgical side or on the same arm for each patient regardless of surgery side. Check your hospital policy prior to using wrist bands. It is important that the entire team has the same routine use of wrist bands to avoid confusion.

### ***Marking the Surgical Site***

Marking the surgical site is also a recommended practice to ensure surgery is conducted on the correct side of the body and to the correct body part.

Ways to achieve this include; asking the patient to draw a dot, 'x' or their initials above the surgical site. Generally it is the surgeon's responsibility for the placement of the mark. In ophthalmology this can be achieved by putting the mark above the eyebrow of the eye awaiting surgery. For bilateral surgery, the mark can be placed above both eyes.

Check your hospital policy prior to using surgical marking. It is important that the entire team has the same routine use of marking the surgical site to avoid confusion.

### ***Patient Schedule***

In order to be certain that the team prepares for the correct patient and to ensure that the correct patient receives the correct care, a patient schedule can be prepared and provided to all the team members in each clinical or surgical area. This list will outline the appointment order for the patients. The scheduled list could include:

- ◆ Patient name, date of birth, surgeon's name, diagnosis, surgery or treatment to be completed, time of arrival, other details depending on treatment, such as anesthetic type and medical alert items (diabetes, allergy, etc.)
- ◆ This list should be generated by one person, such as the administration person and it is placed in an area where the medical team can access it.

If the schedule changes, then the paper list must be up-dated immediately so staff do not unknowingly continue with the old plan (potentially causing error).

*Note: This schedule should not be placed in a public place where patient privacy is compromised.*



### Assessment Activity 1

Please download the Cyber-Sight PowerPoint presentation titled WHO Safe Site Surgery Checklist and complete the quiz at the end of the presentation. Please submit your answers to Orbis as part of your assessment grade.

#### Activity One Grade

	Possible Grade	Your Grade (completed by your Mentor)
Answers to questions	2 points per question	
	10 (%)	



### Assessment Activity 2

Examine the processes that take place at your hospital and answer the questions below:

1. What safe site surgery checking is currently used at your hospital?

---



---



---

2. What other safe site surgery techniques could you recommend to your supervisor as suitable and safer ways to practice in your hospital?

---



---



---

Write your answers on a separate page and submit your answers to Orbis as part of your assessment grade.

#### Activity Two Grade

	Possible Grade	Your Grade (completed by your Mentor)
Correctly indentified Safe Site Surgery	5	
Made appropriate recommendations	5	
	10 (%)	

## Personal Protective Equipment

Personal Protective Equipment (PPE) refers to the use of devices, such as gloves, glasses, masks and work-shoes used by the hospital workers to protect themselves in the workplace. These devices are designed to protect the workers from contracting potential communicable diseases and from sustaining a physical injury.

Some of these devices include gloves, glasses/shields, shoes, gowns, and masks.



### **Gloves**

Gloves can be worn by any worker when there is a potential for cross-contamination. This could take place during a direct patient procedure, surgery, while cleaning instruments or during routine room cleaning and management of waste and linen.

#### *Tips:*

- ◆ Change gloves regularly
- ◆ Wash your hands after you take off the gloves
- ◆ Change gloves if they have a hole (break)
- ◆ Place in the contaminated bin as required
- ◆ Do not touch anything else, such as door handles, the phone or other medical equipment, while wearing contaminated gloves. This is to avoid cross-contamination.



### **Glasses/Shields**

By wearing protective glasses/shields over our eyes we can prevent injury caused by chemicals and detergent, and cross contamination due to a bodily fluid splash into our eyes.

Glasses/shields can be made from clear plastic or glass and should be worn when working within a situation where there is the potential for a fluid splash. For example: cleaning, attending to intravenous fluid lines, inserting an intravenous cannula, assisting a patient with toileting or washing, cleaning surgical instruments and assisting the surgeon.



### **Shoes**

Wearing supportive shoes is essential for nurses as they spend considerable time standing on their feet. Taking care of our feet will prevent long-term health problems which cause injury, stiffness and discomfort. It can also prevent splash-contamination or injury from sharp objects.



*A good shoe:*

- ◆ Covers the toes
- ◆ Has back-heel support
- ◆ Is made from firm or supportive material
- ◆ Has a thick firm sole (under the foot)
- ◆ Can be washed or wiped off regularly

Alternatively an outside shoe can be covered with a disposable or washable shoe cover. This cover must be changed and cleaned every day.

*Note: Peri-operative nurses must ensure that their shoes are cleaned daily. They do not wear peri-operative shoes outside of the peri-operative area.*



### **Masks**

In the operating room, the medical team is required to wear a mask. While there remains international debate about the effectiveness of the mask for protection against air-borne contaminants, there is no doubt that the mask can prevent chemical or bodily fluid splash injury to the medical team. In addition, the mask can prevent the medical team from coughing directly onto the surgical site.

A clean mask should be worn everyday and should not be worn outside of the operating room complex. The mask is only effective if it is covering the nose and mouth.

In some countries, disposable masks are used. These are to be removed and discarded when leaving the operating room and they are replaced when returning to the operating room.

For countries that use a cloth mask, it is important that the mask is cleaned daily and is made of a non-flammable, lint-free fabric similar to the material used for patient drapes and scrub gowns.

### **Manual Handling**

Manual handling is a general term that refers to the movement and care of the body (ergonomics). In particular this refers to the care of staff members when moving, handling and mobilizing patients, equipment and supplies.

This section examines daily and repetitive tasks and their impact on the body over time.

If we do not take care of our bodies we may permanently injure ourselves. Such injury could render us unfit to continue to work and this could impact on our ability to earn money and provide for our families.

Incorrect manual handling can also cause injury to the patient, and could damage equipment.

### ***Principles of Safe Manual Handling***

- ◆ Protect your back
- ◆ Do not twist your spine or bend your back when lifting or moving items
- ◆ To pick up an item from the floor, do not bend from the waist. Instead, bend your knees and get down low.
  - To stand back up, push up from the legs and carry the object close to your body
- ◆ Do not lift anything that is too heavy. Seek assistance from your colleagues and/or use a mobilizing or lifting aid
- ◆ Do not lift anything high above your head
- ◆ Do not pull an object towards you. Instead, move to the other side and push the item
- ◆ Get close to an object to move it
- ◆ To move a patient's bed, manually pump the bed to your waist level in order to use your core body strength
  - If a bed does not have a pump option then ask other nurses to help you, and move the bed as a team. By working together you will share the load and protect your back
- ◆ To lift an item from the floor, bend your knees and get down low. Push up from the legs and NOT the back
- ◆ Do not attempt to lift or move unstable objects
- ◆ Use appropriate lifting and moving devices as much as possible
- ◆ Work as a team and ask for help as much as possible
- ◆ When moving a patient, talk to them before and during the move so they are aware of what will take place. By doing this, you may find, depending on their abilities, that they are able to assist you and make the move easier.

### ***Moving a Patient***

- ◆ Inform the patient what your intentions are prior to moving him/her
- ◆ Ensure that the task will not injure the patient or yourself
- ◆ Examine the patient's skin integrity to ensure that the movement will not cause skin ruptures
- ◆ If a patient is heavy or they have limited mobility it is always best to move them with the help of another nurse
- ◆ Get close to the patient to enable you to use your core strength, and ensure that the patient is safe and supported throughout the duration of the move
- ◆ Try to transfer (help move) the patient from one spot to another, rather than lifting them
- ◆ Remember to talk to the patient before and after the move.



### Assessment Activity 3

Please answer the questions corresponding with the pictures below.

1. True or false: Does picture A, (where the nurse has a bent back), show the use of correct lifting techniques when lifting an item from the ground? T / F

A.



B.



2. Which of these photos show the best way to move a patient bed? Please explain your answer in the lines provided below.

---

---

---

A.



B.



C.



Please submit your answers to your Orbis Mentor as part of your assessment grade.

### Activity Three Grade

	Possible Grade	Your Grade (completed by your Mentor)
Answers to questions	5 points per question	
	10 (%)	

## **Waste Management**

In many parts of the world, hospitals and health care ministries have developed a color coding system designed to help distinguish between general, contaminated and cytotoxic/radioactive clinical waste (waste is also called garbage or rubbish).

Distinguishing these types of wastes helps the hospital ensure that they dispose of the items in the correct manner, thus ensuring safety to the worker, patient, visitor and the general public.

Waste bags should not contain holes and should be tightly closed after use. A waste collector/bin with lid is also recommended.

Waste within the clinical and ward setting are to be removed at the end of each day, or earlier if the bin becomes full. In the operating room however, waste is removed after each patient case.

In both instances the waste should be placed somewhere safe, secure and away from the clinical area until the cleaner or disposal worker can collect them. The collection should take place daily and waste should never be left in the clinical, ward or operating rooms overnight. It is also essential that the waste is not left in an area where small children have access.

Gas cans/cylinders, radioactive/cytotoxic and flammable items should be disposed of carefully to ensure they do not explode during the incineration (burning) process or cause harm to the disposal workers. Check the recommendations written on the item's label or box as this will provide information on correct disposal.

Waste bins, especially the lids, need to be cleaned at the end of each day.



## **Disposing of Fluids**

Fluids, such as medications, balanced salt solution and intravenous fluid bags, and body fluids such as vitreous, lens nucleus, blood and urine, should never be touched as these fluids potentially contain communicable pathogens.

Fluid inside bottles/bags and intravenous bags should not be removed and placed down the drain. The bottle/bag is to be placed directly into the contaminated waste bin for disposal. This method will ensure that nurses are not exposing themselves to potential splash injuries when the fluid is being removed from the bag.

## ***Using Urinals and Bed Pans***

Used urinals or bed pans must be emptied and cleaned, or disposed of after use. Some countries use special automated cleaning machines to do the cleaning while other countries use single-use disposable urinals.

In instances where the urinal must be re-used, the nurse must wear personal protective equipment such as glasses and gloves.

Steps for cleaning include:

- Step 1: Transport the urinal safely to the water closet (bathroom drain/toilet) where the fluid can be poured
- Step 2: Clean the urinal by using a designated scrub brush and approved detergent
- Step 3: Rinse and store somewhere safe and dry
- Step 4: Dispose of, or clean the scrub brush before next use
- Step 5: Wash hands after all above steps

## **Handling Sharp Items**

Used needles, blades, knives or other sharp and contaminated items can carry unseen infectious and potentially lethal pathogens. It is essential for all medical personnel to handle all sharp items correctly in order to protect themselves from risk.

It is also important that sharp items are disposed of in a safe manner to ensure that the disposal workers are protected.

It is also important to prevent young children from accessing used sharp items and unknowingly injure themselves while playing.



## Sharp Handling Tips from Around the World

### ***Sharp Disposal Containers***

Using a sharps' container is standard practice around the world as a method for safety. They house all used sharp items until they are disposed of. Generally these containers will be transported to the hospital's disposal unit where they are incinerated (burned). Disposal containers are designed to protect the hospital workers, cleaners and disposal staff from receiving sharps' injury.



Some countries will use plastic containers, depending on cost and availability, similar to those above. Alternatively a container can be produced out of strong plastic or cardboard.

### **Sharp container tips:**

- ◆ Examine the container before you pick it up or transport it
- ◆ Do not fill to the top. Allow around 1 inch (2.5 cm) at the top to allow you to safely close the container
- ◆ Close the lid carefully and as directed
- ◆ Never leave the container in a place where young children can reach it
- ◆ Make sure your container complies with your hospital or country's color coding system for sharps or contaminated items.

### ***Tip:***

If you do not have a hospital made sharps' container you can always use a plastic bottle. Again, make sure that there are no holes in the plastic and it is strong enough to keep the sharps safe. Do not fill to the top. Secure the lid at the end and tape down shut.

## **Sharp Dish Containers**

When attending to the patient, at the bed side, always place your sharp items in a safety dish so that you know their location when in use. You can then transport the dish safely to the sharps' container after use.

(Sharps in the operating room shall be discussed in the Orbis Peri-Operative Module.)

A.



B.



Photo A demonstrates an unsafe operating room table with sharp needles and blades scattered across the table. This also makes it difficult to count the sharps at the end of the surgery.

Photo B demonstrates the use of a container, colored yellow, which is designed to hold the sharp items on the operating table in a safe and secure manner during use.



### **Reference Reading Activity 2**

1. NIOSH Alert: Preventing Needle Stick Injuries in Health Care Settings [DHHS (NIOSH) Publication No. 2000.108Fact Sheet- Produced by the Centre for Disease Control.
2. Muralidhar.S, Singh.P.K, Jain.R.K, Malhotra.M, & Bala.M. Indian Journal Med Research. Needle stick injuries among health care workers in a tertiary care hospital of India.131, March 2010, pp 405-410
3. Zafar.A, Habib.F, Hadwani.R, Ejaz.M, Khowaja.K, Khowaja.R., & Irfan.S. BMC Infectious Diseases. Impact of infection control activities on the rate of needle stick injuries at a tertiary care hospital of Pakistan over a period of six years: an observational study 2009, 9:78doi:10.1186/1471-2334-9-78
4. Orbis Nursing Powerpoint: Presentation: Blood-Born Pathogens (2002)

## **Linen Management**

### ***Patient Linen***

Linen, such as bed sheets, blankets, pillow cases, patient gowns and towels need to be washed after use to avoid cross-contamination.

Linen is to be cleaned daily or when contaminated with bodily fluids, dirt, animals and other contaminants.

Used linen should not be shared between patients.

In some countries the hospital will provide the cleaning facilities; however in others, the patient's family is required to bring their own linen and clean it. Regardless of these situations the linen can still be scrubbed clean with linen-washing detergent, rinsed, dried and then made ready for their next use.

### ***Surgical Linen***

In many countries the surgical team continues to utilize reusable cloth drapes, towels and surgical gowns, despite an international move towards single-use drapes and gowns.

For example, if your hospital re-uses their surgical linen, it is advised that a clean drape and gown is used for each patient. This requires the surgical team to remove their gowns after each case and place them into the linen bin, along with the used patient drapes, ready for transport to the laundry. All loose contaminants are to be removed from the linen and placed into the dirty linen container prior to sending the linen to the laundry. All surgical instruments and countable items are to be removed from the drapes and counted as part of the World Health Organization's Safe Site Surgery check. Items are not to be sent to the laundry.

Used linen should be placed directly into a laundry bag rather than being placed on the floor. The laundry bag must be secure and labeled as containing linen that is used and contaminated. This ensures that the laundry workers take extra care of the linen and do not contaminate themselves.

Never hold the used linen to your chest. Wear gloves and hold it away from your body.

## **Infection Control**

Infection control is a general term given to a series of preventative safety measures designed to prevent a patient or staff member from spreading or contracting an infection. These safety measures can include day-to-day hand hygiene and personal hygiene, patient surgical pre-wash, food handling, waste disposal, hospital cleaning and airflow management.

### ***Hand Hygiene***

Hand hygiene is recommended: before and after eating or handling food, after using the toilet, after blowing your nose, working with animals or in the garden, and when touching contaminated or harmful substances and waste.

General day-to-day hand hygiene can be completed in 30 seconds with household soap and fresh water.

In the hospital setting, nurses must wash their hands between patient care and between touching of contaminated materials. A 30 second alcohol based hand wash or traditional 40-60 second hand hygiene is acceptable, with approved hospital grade soap.

Nurses performing a patient treatment procedure, such as changing a wound dressing or administering eye drops, must wash their hands before commencing the procedure and again after.

Operating room nurses however, must perform longer surgical hand hygiene between each patient. *This surgical wash technique will be discussed in the ORBIS Peri-Operative Nursing module.*

### **Staff Personal Hygiene**

Personal hygiene refers to a person's daily washing ritual. Every day you are required to wash to ensure that you are clean, fresh, comfortable, and free of contaminants. It is also important that you wash your hair regularly too. A fresh change of clothes is to be worn and no perfumes or colognes are used.

### **Patient Hygiene**

Depending on a patient's physical abilities, the hospital care worker may be required to assist the patient to wash. Fresh water and soap are to be used each time, with special care taken to ensure that any surgical wound dressings do not become wet (or if required, removed and irrigated through prior to a fresh dressing being placed over the wound). A fresh change of clothes is to be worn.



### **Reference Reading Activity 3**

1. World Health Organization. Hand Hygiene: How, why and when Brochure. August 2009

These readings can be downloaded from Cyber-Sight:

[http://www.cybersight.org/bins/content\\_page.asp?cid=1-10491](http://www.cybersight.org/bins/content_page.asp?cid=1-10491)

### **Pre-Surgery Patient Wash**

Patients scheduled for surgery are required to wash before entering the peri-operative (operating room) area. Each procedure requires a different type of wash. There are also a variety of pre-wash options. Each country and hospital may have different processes.

Regardless of the process, the patient must be washed and ready to enter the operating room. In certain parts of the world, and depending on the type of surgery, the patient will wash at home with their normal soap the morning of their booked surgery, while others must wash when they are at the hospital with hospital grade soap.



### Assessment Activity 5

For this activity you are required to create a one page factsheet or poster, in your own language, regarding the World Health Organization’s *Hand Hygiene* recommendations. Once completed, place the factsheet/poster in your work area (this must be completed with the permission of your manager so you will need to explain why this fact sheet is important). Try to place the factsheet above the sinks, in the nurse meeting areas or hand to your immediate colleagues as their own copy of the brochure.

Try and leave some soap and fresh water in the wash areas to help encourage hand washing. Tidy the wash area regularly throughout the day.

Designate one nurse in the team to provide a clean, wet-wash cloth, tissue or fresh water bowl to each patient each morning, evening and before food delivery. This not only helps the patient to achieve daily hand hygiene needs but also provides an opportunity to talk with the patient.

You may hand-write the factsheet/poster or be as creative as you like by drawing or using the computer to design it. You must submit a copy of the factsheet to your Mentor for marking.

#### Activity Five Grade

	Possible Grade	Your Grade (completed by your Mentor)
Content and result	7	
Creativity	3	
	10 (%)	



### Assessment Activity 6

Investigate what pre-operative washing instructions are given to ophthalmic surgical patients in your hospital. Please explain the instructions below and explain why this method works best for your hospital. Outline any improvements that you can recommend to your supervisor to improve this process?

---



---



---



---



---



---



---

Please submit your answers to your Orbis Mentor as part of your assessment grade.

#### Activity Six Grade

	Possible Grade	Your Grade (completed by your Mentor)
Identified current pre-operative instructions in your hospital	5	
Provided suitable suggestions for up-grading of pre-operative patient hygiene	5	
	10 (%)	

## Food Handling

In many countries the hospital provides food (breakfast, lunch and/or dinner) to the patients. The hospital's kitchen staff is responsible for ensuring that the food they are preparing will not cause harm to the patient. The kitchen staff must:

- ◆ Wash their hands regularly
- ◆ Check that the meat is fresh (no smell and no change of color)
- ◆ Check that the vegetables are fresh (no mold/fungus)
- ◆ Wash their cooking utensils and bowls between different food types: This is to ensure that no food is left in the pan, and to decrease the chance of exposure to food-allergy sufferers
- ◆ Try to eliminate animals and vermin, such as rats from the kitchen area. (Rats carry communicable pathogens.)

Regardless of the food being prepared at the hospital or at the patient's home, the nurse must:

- ◆ Check if the patient is on a strict pre-surgery fasting regime (no food before surgery) and explain that the patient will not be receiving food at that time
- ◆ Check if the patient is a diabetic or allergic to any of the foods' content
- ◆ Make sure the non-fasting patient eats every day
- ◆ Ensure that the food is in reach for the patient and that hot food/drinks will not scald (burn) the patient
- ◆ Explain, to the visually impaired patient, what food is being served and where the food and utensils are located
- ◆ Assist those patients who are struggling to eat (or ask a patient relative to help)
- ◆ Ensure the food dishes are cleared away after the meal and taken away from the patient area to be cleaned
- ◆ Food left in the patient area must be placed into a closed container, to deter rats and insects, and disposed of when it has become stale (dry, smelly, moldy or color change)

*Note: Fasting means 'no food'. Patients are often fasted before surgery.*

## Hospital Cleaning

The hospital environment is different to the home environment and needs to be cleaned regularly. Some cleaning can be done daily while others are weekly, monthly and annually. By cleaning the area we can be sure that we have made every effort to reduce cross contamination and exposure to unknown pathogens. This also ensures that the health care team is working in a safe and clean environment.

These cleaning tasks are shared between the nursing and cleaning departments, depending on the size and availability of appropriate staff in each hospital. Cleaning can include:

### ***Daily***

- ◆ Nursing station bench tops/desk
- ◆ Equipment used that day (slit lamps, lens sets and prisms, blood pressure machines, stethoscopes, surgical equipment and recovery anesthetic items etc)
- ◆ Peri-operative work areas: Operating room and anesthetic bays, sterilization room, holding and recovery rooms
- ◆ Phones, doors and door handles
- ◆ Patient beds and bedside tables
- ◆ Floors: brushed and mopped
- ◆ Bathroom: toilet, sink, shower, washbowl
- ◆ Waste bin washed over
- ◆ Plastic or vinyl chairs
- ◆ At the end of each day clean out toilet brushes, wash clothes and buckets. Dispose of dirty water in a safe manner.
- ◆ Bottom of your nursing shoes
- ◆ Staff kitchen/rest areas

### ***Weekly***

- ◆ Equipment such as sterilizers and anesthetic machines (check the manufacture details first)
- ◆ Surgical microscope lenses and other ophthalmic viewing devices (with approved cloths)
- ◆ Walls and windows

### ***Monthly***

- ◆ Dust clean inside cupboards and shelves
- ◆ Material based pillows and mattresses
- ◆ Bed and trolley wheels (both in the patient stay area and the operating room)

### ***Third Monthly (quarterly)***

- ◆ Window curtains
- ◆ Privacy curtains dividing patient beds
- ◆ Walls and ceilings not usually in reach by the nurses
- ◆ Inside nursing staff change areas or lockers
- ◆ Chairs made of a fabric material

### ***Personal Cleaning Tip***

The nurse's personal equipment, such as pens, scissors and clip boards, can also harbor contaminants. Wipe down your equipment regularly throughout the day.

## **Airflow Management**

In many hospitals around the world the air entering the hospital environment is filtered to ensure that any particles do not contain harmful particles. Temperature control is also important to prevent harmful particles from multiplying. In general the temperature is maintained at approximately 20 – 24 degrees Celsius.

Within the operating room this air and temperature environment can only be maintained by special filters located in the ceiling. Closing the doors and windows also helps maintain the temperature.

The air is generally blown into the area in a certain direction to ensure that the air is still and particles are resting.

In other parts of the world however, the air and temperature is more difficult to manage and control, due to limited resources. Certain hospitals do not have temperature control options, so windows and doors remain open, to allow a cooler breeze to move through the area. While this ensures the area is easier to work in, it enables harmful bugs, particles and dust to enter the area. Ceiling fans are also used to cool the area, however these can further blow particles around the room.

Often environments cannot be altered and the nurse must ensure that regular cleaning takes place to reduce the amount of contaminants. Try to ensure the best environment you can within your hospital circumstances.

*Orbis will discuss the peri-operative airflow and environmental management in detail within the Peri-Operative module.*

## **Workplace Health and Safety (WPHS)**

Workplace Health and Safety is a term that describes the preventative measures put in place by a hospital to ensure that the health care workers, patients and visitors are safe from injury.

It is essential that the nurse complies with these safety measures. WPHS includes the above topics:

- ◆ Infection control
- ◆ Airflow management
- ◆ Handling sharps
- ◆ Waste and linen management

In addition WPHS describes safe chemical and detergent storage and handling and safe equipment use, maintenance, and spills and dangers.

### ***Spills***

Occasionally fluids, oils and chemicals are accidentally dropped on to the floor. When this happens it is important that health workers and nurses remove the fluids as soon as possible in order to prevent a person from slipping and falling, resulting in injury.

When a spill occurs, the nurse must:

- ◆ Isolate the area with a 'slip sign' or remain in the area
- ◆ Notify staff and visitors in the area of the location of the spill until it is cleaned away
- ◆ Determine what the fluid is made of and read the label on the bottle to determine the best method for mopping up
- ◆ Obtain the appropriate mop and bucket as directed on the fluid's bottle
- ◆ Once mopped-up, leave the spill sign in the area until the floor is dry
- ◆ Dispose of the dirty cleaning fluid and wash out the mop and bucket

### ***Dangers***

Common dangers in the hospital include:

Faulty electrical wiring, water dripping on to electrical equipment, over-worked and heated-up power points (plugs) and power boards, live-wires sticking out of the wall, electrical wires in the walkway, uneven and loose flooring, holes and gaps in the floor or ceiling, unfinished building work resulting in sharp jagged edges and other workplace hazards.

While it is not the nurse's responsibility to fix and maintain electrical points, the nurse is responsible for informing their managers of the potential hazard. Then, depending on resources, the hospital manager can arrange for the hazard to be fixed as soon as possible.

While waiting for the hazard to be fixed, the nurse should avoid the hazard and ensure patients are safe and away from this danger. A 'danger' sign can be placed in the area to alert people of the hazard, or the area can be locked to prevent entry.

### ***Fire and Evacuation***

In the event that the hospital is on fire, or the area needs to be evacuated, the nurse must ensure that they, and the patient, safely vacate the area before they are seriously injured or worse, trapped.

To ensure that the nurse and patient can leave the hospital quickly, some tips to assist are given below:

- ◆ Make sure all the hallways and exit doors are cleared of equipment, stock and patient beds
- ◆ Make sure that all fire exits can be opened from the inside of the room without having to obtain a key
- ◆ Place fire blankets in convenient parts of the hospital
- ◆ Install an alarm system so that it can be used to alert other staff that there is a fire



## Assessment Activity 7

Please answer the quiz below and submit your answers to Orbis for grading.

This assessment is open book exam. Worth 40% of your grade (4 points per question)

1. True or false: The surgical site should be marked before the patient goes to surgery? T/ F

2. What are the 5 steps of the World Health Organization's *Hand Hygiene* recommendations?

1. \_\_\_\_\_ 2. \_\_\_\_\_ 3. \_\_\_\_\_

4. \_\_\_\_\_ 5. \_\_\_\_\_

3. True or false: Gloves should be worn when handling contaminated or used linen? T/ F

4. Why should a sharps' container be used?

---

---

---

5. How often should the floors be cleaned in the hospital? \_\_\_\_\_

6. True or false: You should always try and lift and move every item and patient without asking for help? T/ F

7. In what situations should the nurse wear a goggle/shield over their eyes?

---

---

---

8. How would you dispose of lens matter removed from the eye during cataract surgery?

---

---

---

9. True or false: Surgical masks can be worn for weeks without being cleaned or changed? T/ F

10. Which members of the medical team are responsible for completing the World Health Organization's *Safe Site Surgery* 'time-out' *checklist*?

---

---

---

---

### Activity Seven Grade

	Possible Grade	Your Grade (completed by your Mentor)
Answers to questions	4 points per question	
	40	

## References:

AORN: Peri-Operative Standards and Recommended Practice (2010). AORN Publication, Denver, USA.

1. Recommended Practice: Surgical Attire. Pg 67
2. Recommended Practice: Traffic Patterns. Pg 101
3. Safe Patient Handling and Movement. Pg 673
4. Ergonomic Tool #6: NIOSH Lifting index value for physical lifting of objects. Pg 684
5. Ergonomic Tool #7: Recommendations for pushing, pulling and moving equipment on wheels. Pg 686
6. Sharp injury prevention. Pg 697
7. Noise in the peri-operative setting. Pg 721
8. Correct Site Surgery. Pg 708

Muralidhar.S, Singh.P.K, Jain.R.K, Malhotra.M, & Bala.M. *Indian Journal Med Research*. Needle stick injuries among health care workers in a tertiary care hospital of India.131, March 2010, pp 405-410

NIOSH Alert: *Preventing Needle Stick Injuries in Health Care Settings* [DHHS (NIOSH) Publication No. 2000.108Fact Sheet- Produced by the Centre for Disease Control.

Orbis Nursing PowerPoint: *Presentation: Blood-Born Pathogens* (2002)

WHO (2008) Safe Site Surgery Guidelines <http://www.who.int/patientsafety/safesurgery/en/>

Zafar.A, Habib.F, Hadwani.R, Ejaz.M, Khowaja.K, Khowaja.R., & Irfan.S. *BM. Infectious Diseases*. Impact of infection control activities on the rate of needle stick injuries at a tertiary care hospital of Pakistan over a period of six years: an observational study 2009, 9:78doi:10.1186/1471-2334-9-78



## World Health Organization's (WHO) Safe Site Surgery Competency ©

### How to use this competency

*Face-to-face during Orbis program:* You will be asked to participate in the Safe Site Surgery process and you will be observed by your Mentor and marked as below.

*Distance-student:* Please liaise with your Orbis mentor and hospital manager. The Orbis Mentor will guide your manager on how to observe you during the Safe Site Surgery process and complete the items below.

Competency	World Health Organization's (WHO) Safe Site Surgery			
Department	Nursing: All Areas			
Staff Nurse Name				
Date				
Aim of Competency	Develop competence and independence in the practice of safe site surgery as outlined by the World Health Organization's Safe Site Surgery Guidelines. This policy has also been developed to meet the Correct Surgical Site Statement as outlined by the Association of Operating Room Nurses (AORN), and ORBIS policy			
	Principles	Competent and Independent	Competent with Supervision	Not Competent
1	Demonstrates understanding of Safe Site Surgical policy and the WHO guidelines, and performs duties within this role			
2	Participates, with other members of the clinical team, to ensure that the Safe Surgery guidelines are adhered to at all stages of the patient's care			
3	Alerts the team to discrepancies as and when they occur and supports other team members to complete their Safe Site Surgery check list requirements			
4	Completes nurse check sheets, prosthetic paperwork and item checks, and patient and department documentation as required			
5	Works with inter-disciplinary clinical team to ensure all checks, surgical instrument items have been accounted for prior to closure or drape disposal			
Has competency been achieved?	Yes / No		Supervisor Comments:	
Staff Nurse Signature			Date	
Supervisor/Mentor			Date	

## Appendix A

### Unit Conversion Tables

#### Length Conversion

Imperial/USA unit	Metric (SI) unit	Metric (SI) unit	Imperial/USA unit
Inch	2.54 centimeters	Centimeter	0.39 inches
Foot	30.48 centimeters	Meter	3.28 feet
Yard	0.91 meters	Meter	1.09 yards
Mile	1.61 kilometers	Kilometer	0.62 miles

#### Weight (mass) Conversion

Imperial/USA unit	Metric (SI) unit	Metric (SI) unit	Imperial/USA unit
Ounce (weight)	28.35 grams	Gram	0.035 ounces
Pound	0.45 kilograms	Kilogram	2.21 pounds
UK ton (2240 pounds)	1.02 metric tons	Metric ton (1000 kg.)	0.98 UK tons
US ton (2000 pounds)	0.91 metric tons	Metric ton (1000 kg.)	1.10 US tons

#### Temperature Conversion

- $^{\circ}\text{C} = (^{\circ}\text{F} - 32) \div 1.8$  For example:  $(68^{\circ}\text{F} - 32) \div 1.8 = (36) \div 1.8 = 20^{\circ}\text{C}$
- $^{\circ}\text{F} = (^{\circ}\text{C} \times 1.8) + 32$  For example:  $(20^{\circ}\text{C} \times 1.8) + 32 = (36) + 32 = 68^{\circ}\text{F}$
- Freezing =  $0^{\circ}\text{C}$  ,  $32^{\circ}\text{F}$
- Room temperature =  $20^{\circ}\text{C}$  ,  $68^{\circ}\text{F}$
- Normal body temperature =  $37^{\circ}\text{C}$  ,  $98.6^{\circ}\text{F}$
- Boiling point of water =  $100^{\circ}\text{C}$  ,  $212^{\circ}\text{F}$

#### Volume (capacity) Conversion

Imperial/USA unit	Metric (SI) unit	Metric (SI) unit	Imperial/USA unit
Teaspoon (UK)	5.92 milliliters	Millilitre	0.17 teaspoons (UK)
Teaspoon (US)	4.93 milliliters		0.20 teaspoons (US)
Tablespoon (UK)	17.76 milliliters	10 Millilitre	0.56 tablespoons (UK)
Tablespoon (US)	14.79 milliliters		0.68 tablespoons (US)
Fluid ounce (UK)	28.41 milliliters	100 millilitre	3.52 fluid ounces (UK)
Fluid ounce (US)	29.57 milliliters		3.38 fluid ounces (US)
Pint (UK)	0.57 liters	Liter	1.76 pints (UK)
Pint (US)	0.47 liters		2.11 pints (US)
Quart (UK)	1.14 liters		0.88 quarts (UK)
Quart (US)	0.95 liters		1.06 quarts (US)
Gallon (UK)	4.55 liters		0.22 gallon (UK)
Gallon (US)	3.79 liters		0.26 gallons (US)

#### Normal Blood Sugar Level for Diabetic Patients

After a meal-  $<10.0$  mmol/l ( $<180$  mg/dl) to convert mmol/l to mg/dl multiply by 18  
 Before a meal-  $70\text{--}130$  mg/dl ( $5.0\text{--}7.2$  mmol/l) to convert mg/dl to mmol/l, divide by 18



## Module 2: General Equipment Care ©

### Module Outline

This module includes:

- ◆ Safety First
- ◆ Reporting damaged equipment
  - Biomedical Engineer Department
  - Electrician Department
- ◆ Storage in hot and cold climates
- ◆ Testing and maintenance
- ◆ Using electrical equipment
- ◆ Wall sockets
- ◆ What is an electric shock
- ◆ Water and electricity do not mix
- ◆ Power boards – over use and overheating
- ◆ Using gas cylinder equipment
- ◆ Using battery-operated equipment
- ◆ Bulbs (light globes)
- ◆ Fuses
- ◆ Electrical cords
- ◆ Caring for accessory equipment
- ◆ Cleaning
- ◆ Tips for managing your equipment

### Module Objectives

1. Promote safe handling and use of equipment
2. Promote a safe work environment culture
3. Improve patient safety and surgical outcomes
4. Prolong the life and use of equipment and accessories
5. Decrease hospital costs due to equipment damage and misuse

This module includes 2 assessment activities.

You will need to register and submit the 2 activities to your Orbis Mentor should you wish to receive a certification of completion.

## **Safety First**

As nurses, we are often required to use electrical, battery or gas-powered equipment in order to provide medical and surgical treatment to our patients.

Without an understanding of the functions, limitations and set-up requirements of our equipment, we are potentially placing our patient, ourselves and our colleagues in harms way.

Not only could we cause injury to a person, but we could also permanently damage the equipment through misuse, and render the equipment out-of-action for further use.

As nurses, we are the end user for the equipment and we are responsible for:

- ◆ Being familiar with the equipment prior to use
- ◆ Reading and referring to the manual for guidance
- ◆ Reviewing the area for hazards prior to set-up
- ◆ Ensuring all accessories are ready and working during set-up
- ◆ Ensuring that the equipment is not damaged (e.g. broken cords with live-wires exposed)
- ◆ Reporting damaged or dangerous equipment
- ◆ Checking that the equipment performs the correct functions for the treatment we want to provide
- ◆ Ensuring the equipment is used for its intended purpose
- ◆ Setting-up and closing-down the equipment safely and as directed in the manual
- ◆ Cleaning the equipment between use
- ◆ Storing the equipment
- ◆ Ceasing (stopping) use of malfunctioned or damaged equipment until fixed
- ◆ Following established institutional policies and procedures concerning equipment and facilities safety

Unless you are trained by an equipment or building specialist, you must not:

- ◆ Attempt to fix the equipment beyond the user guidelines written in the manual
- ◆ Open up the equipment outer-casing and fiddle with the wires, software, lenses or bulbs
- ◆ Try and fix the hospital building

These actions could result in further irreversible damage to the equipment or hospital building and cause injury to the patient or yourself.

## **Reporting Equipment Damage**

If you find equipment that is damaged, do not use it. Instead, use established reporting procedure/channels in your hospital to inform your supervisor so that the equipment can be fixed or replaced.

If you find that your hospital does not have an established process for reporting and fixing equipment, try to discuss, with your supervisor, the need for a process to be established.

If you find broken wall power points/plugs, water dripping near electricity or malfunctioned equipment, again, do not use them. Instead isolate the area and inform your supervisor immediately.

Isolate an area by:

- ◆ Ceasing (stopping) use of the equipment immediately
- ◆ Asking people in the area to move away until it is safe
- ◆ Placing a 'do not go near' sign in the area
- ◆ Informing your supervisor immediately so they can get help
  - If your supervisor is not there, contact the biomedical, electrician or maintenance department in your hospital immediately. Ask them to come and help you
  - Try and remove the power from the equipment or stop the dripping water. ONLY IF you are out of harm's way

### **What is the Biomedical Engineering Department?**

Most hospitals around the world have a biomedical engineering department (also known as a clinical engineering, medical instrumentation or medical equipment maintenance department) that is responsible for maintaining, repairing and testing medical-specific equipment such as oxygen supply systems, anaesthetics machines and microscopes. They conduct regular machine checks and emergency checks. You may need to contact this department if your equipment stops working.

### **What are the Electrician and Maintenance Departments?**

Within your hospital there will be a team of specialists, known as an electricians and maintenance, facility engineers or the building maintenance department, that are dedicated to testing, maintaining and fixing the hospital building. They are responsible for the care of:

- ◆ Electrical wires and plugs
- ◆ Water pipes and taps
- ◆ Air conditioning, lighting and electric doors
- ◆ Flooring, walls, roofs, doors and windows
- ◆ Outside areas
- ◆ Non-medical equipment

Should you find yourself in a hazardous situation and/or your equipment is damaged because of a building issue, you may need to notify your supervisor so that they can contact the electrician and maintenance department.

## Storage in Different Climates

Some equipment is sensitive to dusty, damp, hot and cold climates and their ability to function can be compromised if they are not stored correctly. Therefore, it is important to understand your equipment and ensure that they are not permanently damaged through incorrect storage.

Dust and dirt can often get inside the machine causing the machine to malfunction.

To prevent this from occurring place a dust-cover over the machine after use. In hot/humid climates plastic equipment covers actually promote the growth of fungi especially on optics.

**Cotton covers, e.g. bed sheets or pillow cases, make excellent covers.**

Damp, moisture in the air, due to rain or humidity can cause lens fogging, plastic disintegration and damaging mold build-up.

Dehumidifiers are recommended to protect expensive and sensitive equipment. Additionally they help achieve acceptable levels of humidity for sterility purposes.

Hot temperatures, similar to damp, can disintegrate the materials and cause permanent damage.

Cold temperatures can freeze or jam the equipment.

Rapid temperature changes such as turning on/off air conditioning systems can cause more rapid growth of fungi/molds on optics and other equipment components. If possible leave air conditioning systems on 24/7.

Take a look at the equipment manual or ask your biomedical engineering team to help check that your equipment is being stored correctly.



## Activity Assessment 1

You are required to select either a slit lamp or surgical microscope in your ophthalmology department and answer the below questions. You may need to ask your supervisor or the doctor to help you and you may need to read the equipment's manual in order to answer the questions.

### Questions

Slit Lamp / Surgical Microscope (please circle)

Brand on Equipment: \_\_\_\_\_ Model Number: \_\_\_\_\_

What is it used this for? : \_\_\_\_\_

How often is it used? : Daily / weekly / monthly

Does it have a dust cover? Yes / No

How often is it checked by the biomedical engineering team? \_\_\_\_\_

Where is it stored? What are the temperature, cleanliness, tidiness and accessibility of the storage room?

\_\_\_\_\_

How is it stored?

\_\_\_\_\_

Now, investigate the equipment a little further. How can this equipment be better stored, cared for and maintained in order to ensure it will continue to function for years to come? What would you recommend?

\_\_\_\_\_

\_\_\_\_\_

\_\_\_\_\_

Please submit your answers to Orbis for certification.

### Activity One Grade

	Possible Grade	Your Grade (completed by your Mentor)
Identified Current Equipment Care system	25	
Provided suitable suggestions for up-grading equipment care	25	
	50	

## Getting Equipment Ready: *The End User Test*

As nurses we are responsible for testing that our equipment is ready for use before we use it on our patients. Your test should include:

- ◆ Checking the integrity of the equipment
- ◆ Ensure all accessory equipment is ready and working
- ◆ Plugging-in, opening or switching on the equipment
- ◆ If the manual suggests that the 'user' needs to test that the equipment is functioning prior to use, you may perform the test in a safe manner (Do not attempt to test beyond the normal plug-on, turn on and user-panel. Do not open up the machine to test or change settings)
- ◆ Complete a test cycle then turn-off, close or un-plug the equipment as suggested in the manual.

If the machine passes the user-test then it is safe to use.

If the machine does not pass the test, perform a second or third test. If it continues to fail then you must inform your supervisor and/or the biomedical engineering, electrical or maintenance department (depending on the reason for test failure) so that it can be fixed or replaced.

Do NOT use equipment that does not pass after a third try.

Do NOT use the equipment on the patient until it has been fixed.

## Using Electrical Equipment

Equipment such as slit lamps, microscopes and sterilizers all require electricity in order to function. The electrical department must be informed, immediately, of any electrical issues.

Always turn off at the Off Button after use. Then, unless it is recharging, turn it off at the wall socket (power point/plug) or simply unplug it after you have closed down.

*Note: Always make sure that live-power is not accessible to children. Do not allow children to place items, especially items made of metal, into a power point/plug. This can cause electrocution and a potential power-outage through out the building.*



### Wall Sockets (power points/plugs)

A wall socket is the point where electrical equipment can be placed into the wall's power supply. While plugging an electrical cord into a wall is a simple process, the actual power supply voltage could be different to the equipment's needs. In some instances a 'transformer' may be needed to change the voltage. Therefore, please ask your biomedical engineer or electricians to check that it is safe for you to plug certain items into certain wall sockets. If the voltage is not the same, the electrical difference could permanently damage the equipment and/or the hospital building's power supply.

Electricity can be dangerous and can cause electric shock to a person. If mixed with water it can also be deadly. Therefore care should be taken at all times. The next section will explore this in more detail.

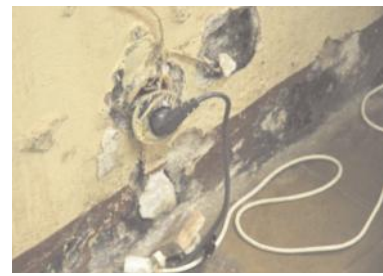

Examples are shown of wall sockets that are damaged and unsafe for use

### **What is an Electric Shock?**

“A person’s body is an efficient conductor of electricity and can be mistaken as part of the electric circuit. This can cause an electrical shock.”

“Shock can occur when a person’s body completes the electrical current path with: both wires of an electric circuit, one wire of an energized circuit and the ground, a metal part that accidentally becomes energized due, for example, to a break in its insulation, or when another “conductor” carries a current.”

“When a person receives a shock, electricity flows between parts of the body or through the body to a ground or the earth.” ...

“This can lead to a slight tingling sensation all way to a cardiac arrest”.

OSHA (2002) *Occupational Safety and Health Administration*: OSHA-3075 Controlling Electrical Hazards.

### **Water and Electricity Do Not Mix**

When water and electricity mix, they can cause electrocution and death and lead to a potential power-outage throughout the hospital building.

#### ***Preventing Water-Electricity Mix and Harm***

- ◆ Regularly review your department and immediately notify the electrician and maintenance department of any water that is dripping on or near electrical equipment, a wall socket, air conditioning unit, power board or the power-main switch (usually located outside)
- ◆ Remove any hazards
- ◆ Never touch water-electrical live wires with bare hands
- ◆ Do NOT touch exposed live electrical wires, under any circumstances. Always contact the biomedical engineering or your electrical department for repair. Ensure that the immediate area is quarantined until repairs are affected.

Additionally, some specialists believe, and advise, that wearing shoes made of rubber will also prevent the conduction of the electricity.

### ***Managing Dangerous Situations Caused by Water-Electricity Mix***

- ◆ Evacuate the area immediately
- ◆ Ask your supervisor or associates to contact the electrician and maintenance department immediately
- ◆ If there is no one to help you, without placing yourself in harm's way, try to unplug or turn off the electrical supply. You may wish to wear rubber shoes and gloves too
- ◆ If it is too difficult and dangerous to turn off the electricity, instead evacuate and isolate the area to prevent other people from entering and being harmed
- ◆ Continue to seek help. The electricity must be turned off in order to prevent the water from becoming live and dangerous
- ◆ The water mains can also be turned off but ONLY if you are not in harms way.

### **Power Boards – Over Use and Over Heating**

When there are not enough wall sockets to run our electrical equipment, we can often plug in a multi socket power board, also known as an outlet-strip or extension cord, and run several electrical equipment items at the same time.

While this is practical, there are hidden fire dangers involved when the board overheats through excess work. This could lead to equipment damage, power-outage in the hospital building, or fire. It is also a leading cause of circuit overloading causing the electrical distribution panel circuit breaker to trip cutting off electrical power to the power board and other outlets on that circuit.

Other dangers include excess power cords being trailed across walk-ways in order to reach the power board. This could cause someone to trip over and sustain an injury. Therefore try and tidy the cords to ensure they are out of the walk ways or try and find alternative power supplies.

*When using a multi power board:*

- ◆ Do not clean with a wet cloth. Instead dust it with a dry cloth
- ◆ Check the board regularly to ensure it is not over heating
- ◆ Report any overheating to your supervisor
- ◆ Do not place the power board on a wet floor especially in a water puddle.



## **Using Gas Cylinder Equipment**

Some equipment, such as the anesthetic machine, and the cryotherapy machine, require pressurized gas in order to perform. Regardless of the purpose or type of gas, nurses are often required to set up and change the gas supplied before, during and after the surgery.

In many countries around the world gas cylinders are color coded to ensure that they can be identified. That said, this is not universal.

As nurses, it is important that we are familiar with the cylinder colors in our country and hospital. If colors are not standard, we must pay special attention to reading the gas label on the top of the cylinder.

### ***Storing Gas Cylinders***

Gas cylinders need to be stored in a secure position. They must not be left without being chained down or placed in a buckle, clasp or wall brace. This is to protect them from falling over and, on impact with the floor, exploding and causing damage to the building or injury to people in the area.

If your cylinders are not secure, chat with your supervisor and biomedical engineering team to see if they can design a secure storage system.

### ***How to Tell if the Gas Cylinder Needs to be Changed***

It is not good nursing practice to wait until the doctor complains, during use, that the equipment is not working because the gas cylinder is empty. Such a situation, especially with anesthetic machines, could cause a serious medical safety risk to the patient.

Instead, the nurse is responsible for preventing such an issue by checking that the gas cylinder has enough gas inside it to complete the required surgery/procedure.

Each gas cylinder has a measuring system with a movable pointing-strip. The strip is known as a Gauge. The gauge will move up and down depending on if the cylinder is full or empty. It is ideal for the gauge to be in the 'green' rather than the 'red'. (Green means 'Go' and red means 'stop'.)

Before every surgery/procedural case the nurse must check the position of the gauge to make sure the cylinder is in the 'green'.

The nurse must also know where to find a replacement cylinder should they need to replace the cylinder in an emergency. If there are no other gas cylinders available or limited availability, the nurse must inform the doctor before starting the procedure.

This information will help the doctor review the alternatives or re-design the treatment for that day. Finding out halfway through the procedure that they can not continue could, again, seriously compromise the patient.

As nurses, if we find empty gas cylinders, we are responsible for informing the biomedical team, and our supervisor, to ensure a replacement cylinder is supplied.

### ***What Do You Do with an Empty Gas Cylinder?***

A known empty gas cylinder must be replaced immediately so the equipment can be used. The old cylinder needs to return to the biomedical engineering team (or other team, depending on your hospital) to be re-filled. The nurse must:

- ◆ Contact the supervisor or biomedical engineer to come and collect the gas cylinder for replacement
- ◆ Ask the supervisor or biomedical engineer to bring a new spare gas cylinder
- ◆ Place a sign on the cylinder saying 'cylinder empty' so the empty cylinder can be identified and changed over.

### ***Working with Gas Cylinder Wall Banks***

In some hospitals around the world a sophisticated system has been designed to prevent equipment, such as anesthetic machines, from malfunctioning during use due to the changing-of-cylinder time-lag.

These systems have multiple cylinders and back-up replacement cylinders lined up and connected to the same wall pipe. The wall pipe feeds straight to the operating room and to the anesthetic machine.

When one cylinder empties, the system will automatically switch to another cylinder. This way, the anesthetic team only has to check and replace empty cylinders once a day or when the system alarms.

In this instance, the wall bank is generally managed by the anesthetic, biomedical and building supervisor teams. That said, it is advised that non-anesthetic nurses working in the operating room, visit the wall-bank system so that they know where it is located and can understand the principles behind the system.

Note: Depending on the hospital, other surgical air and wall-oxygen systems can be managed using the same system.

### ***Changing a Gas Cylinder***

Do not change over a gas cylinder until you have been trained to do so by your supervisor or the biomedical engineering team. This is to ensure your safety. Once trained, you will find that all gas cylinders and tubing have similar pin-and-valve systems.

You must turn off the valve first, then un-screw from one cylinder and place onto another cylinder. Follow the same 'pin-valve' pattern.

To turn on and off the cylinder: *Turn Right to Tighten, and turn Left to Loosen*



Incorrect storage of a cylinder



## Tips for Setting up Gas Cylinders and Tubing

- ◆ Check the integrity of the gas tubing
- ◆ Ensure you identify the correct gas required for your machine
- ◆ Connect the gas tubing to the machine and to the gas outlet. Make sure the tubing has 'clicked in'
- ◆ Turn on the gas cylinder and loosen the knob until the gauge is in the green
- ◆ When you have finished using the machine, turn the gas off first prior to turning off the machine and disconnecting the gas tubing
- ◆ Never disconnect the gas line during use. This could potentially alter the function of the machine and cause an extreme force of gas to expel and lead to possible injury.

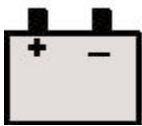

## Using Battery Operated Equipment

Some equipment items require battery power. Some single-use items are supplied with an internal battery while others require the battery to be changed.



## Tips on Caring for Battery Equipment

- ◆ Always carry a back-up of the battery you need
- ◆ Try and purchase rechargeable batteries and a recharger. This will cut down long term costs and waste
  - Do not attempt to recharge regular batteries
  - Rechargeable batteries have a life span of about 500-1000 uses
- ◆ Remove all batteries from unused equipment because they might leak acid into the equipment causing corrosion, which causes permanent damage



Incorrect Batteries can corrode and cause more damage.

## **Bulbs (Light Globes)**

There are a variety of different bulbs on the market designed to fit a variety of equipment. As nurses we must test to make sure the bulb inside the equipment is working prior to use. If it is not working we must change the bulb.

This can be done with assistance from the biomedical engineer, or if you have been trained or read the manual, you can change the bulb yourself, as directed.

### ***Prolonging Life of Bulbs***

To ensure your bulb lasts a long time, try and turn on the equipment at the lowest voltage setting. This is because a sudden high voltage power surges can 'blow' the bulb and it will no longer be usable.

If possible try and use the equipment at the lowest setting. Turning the equipment off after use will also prolong the life of the bulb. Before moving the equipment after use, allow the bulb to cool after you turn the equipment off (5 minutes or more is ideal) Hot bulb filaments are very fragile and break easily.

When a bulb has 'blown' you will notice that inside the bulb the small 'squiggly' filament in the centre of the bulb, as shown below, will be broken in the middle. This indicates that you will need to change the bulb.

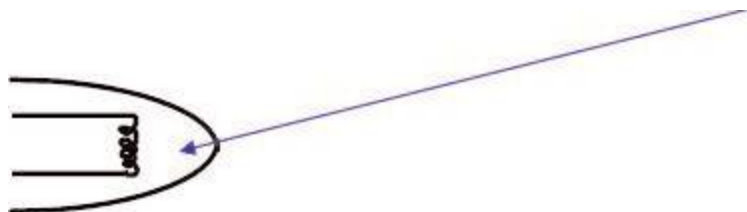

### ***Removing and Installing Bulbs***

- ◆ Shut off machine and unplug
- ◆ Let bulb cool down before removing
- ◆ Do not touch the bulb directly with your fingers. Instead, use a tissue or clean cloth to prevent oil deposits, from your skin, becoming an imprint on the bulb
- ◆ Observe correct alignment of filament to prevent uneven light being projected
- ◆ Know how each specific bulb fits and place the bulb into the socket (you will need to know what type of bulb and socket you are working with. See next page).

## Types of Bulbs

The pictures below show that there are many types of bulb connectors. Therefore it is important that you are familiar with the type of connector you need in order for the bulb to be placed into the equipment.

Straight Push-In Pronged Bulb

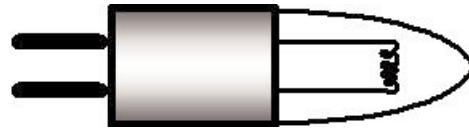

Bayonet Mounts Bulb

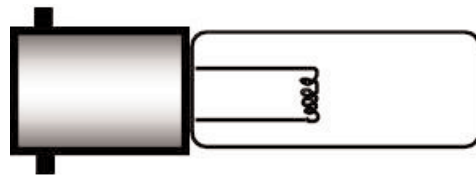

Screw-In Bulb

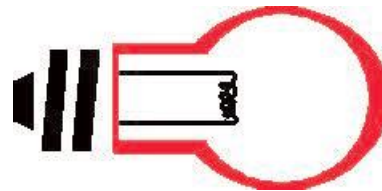

## Fuses

Fuses are tiny changeable equipment parts designed to prevent electrical equipment from overloading.

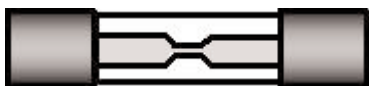

From time to time a fuse can 'blow' and it will alter the function of the equipment. In most instances the equipment will stop working.

When your equipment stops working, the fuse is one of the first parts of the machine that the biomedical engineer and electrician will check.

Do not attempt to examine or exchange the fuse. Instead ask your supervisor to contact the biomedical or engineering department. This is because there are many different types of fuses all with different power abilities. Placing the wrong fuse in the equipment could cause serious damage.

## Electrical Cords

Always make sure equipment cords are in good condition. You are required to examine them before each use and report any breaks, exposed wires or connection problems. Do not use the equipment until the biomedical or engineering team has reviewed the safety of the cord and/or provided you with a new cord.

When removing the cord from the equipment and wall socket after use, pull from the solid connection parts rather than the cord itself. This will prevent strain damage to the cord.



Try to make sure that the cords are not left dangling in a walkway as this may cause someone to fall over and injure themselves. In addition, when a person falls over, they could accidentally remove the cord from the wall socket. This would mean that the equipment will stop working and the patient could be placed at a serious safety risk.



## Caring for Accessory Equipment

A majority of medical equipment can only function with accessory items. For example, a slit lamp can not function without the patient head rest, the phacoemulsification-cataract surgery machine can not function without the phacoemulsification hand piece, and the anesthetic machine cannot ventilate without inhalation gasses.

Regardless of the department you work in, or the equipment you use, you are responsible for looking after the storage, handing and usage of equipment accessories within your department. This is the responsibility of all nurses in your team.

When learning about the equipment, try to read the manual or seek advice from your team and the biomedical engineering department to ensure you are familiar with accessory equipment care. You are then required to store, handle and use the accessory equipment as recommended. You are also responsible for reporting and replacing damaged accessories.

## **Cleaning**

Cleaning equipment and accessories is required before and after use and between patients. Before cleaning, ensure you are familiar with the equipment cleaning recommendations because different cleaning solutions can have different effects on equipment such as corrosion or color change. Make sure you know what the equipment is made of (metal or plastic), if the equipment is electrical, battery operated or neither (damp or dry clean) and if the cleaning product you are going to use will damage the equipment.

### ***Before Cleaning***

- ◆ Read the equipment manual
- ◆ Read the cleaning product instructions to ensure it can be cleaned
- ◆ Turn off and unplug electrical equipment
- ◆ Do not spray cleaner on the surface. Spray cleaner on a towel first. This prevents solution from running into the machine

### ***General Equipment Cleaning Between Patients***

- ◆ Wipe the surface areas touched by the patient and staff
- ◆ Use a different cleaning cloth each time
- ◆ Clean or replace accessory equipment
- ◆ Wipe over areas of known contamination, such as blood

### ***General Equipment Cleaning at the Beginning and End of the Day***

- ◆ Clean the outside of the equipment, from top to bottom
- ◆ Clean the areas touched by the staff and the patient
- ◆ Remove and clean any accessory equipment (discard or prepare for surgical clean as required)
- ◆ Clean any power cords and gas tubing
- ◆ Clean the wheels or legs of the machine
- ◆ Replace dust covers and store away

### ***Cleaning Lenses***

- ◆ Blow dust off the lens
- ◆ Use soft tissue-cotton
  - You can also purchase special lint-free microscope tissues
- ◆ Alternatively wet a cotton-tip with a drop of distilled water

### ***Preventing Fungus Growth***

- ◆ Keep equipment covered when not in use
- ◆ Keep equipment in a dry place preferably with a dehumidifier or an air conditioner

- o In certain equipment, in humid climates, you may need to insert fungus prevention pellet into the equipment. Only do this if the equipment manual advises and discuss this with your supervisor or biomedical engineer before doing so. As mentioned earlier, cycling of air conditioning (A/C) and/or dehumidifiers by turning them on in the morning and off at the end of the day poses more risk than no A/C or dehumidifiers at all. The optics can become cold with the A/C, and can then create condensation in humid air.



## Tips for Managing Your Equipment

If you do not have an in-hospital biomedical or electrician team, you may need to keep a track of your own equipment needs. Below are tips on how you can keep track of your equipment.

1. Write a list of all the equipment you have in your department. You will need to write down the brand, how and where they are stored, bulbs and fuses needs and any accessory equipment items that are required
2. Give the equipment identification numbers to correspond with your written list
3. Keep a record of when the equipment was checked by a biomedical or electrical person. This will help you schedule the check for next time. Try and aim for a 6 monthly or annual check, unless recommended otherwise. The same applies to wall socket checks
4. Keep backup bulbs, batteries, fuses and cords, and accessory items for all of your equipment
  - a. Regularly check your backup stock to make sure they are still available
  - b. In the instance of batteries, check that they have not corroded
5. Find out the contact details of external equipment and emergency biomedical and engineering companies (as approved by your supervisor) and place their contact telephone numbers close to the phone or nurses work station so that they can be contacted in an equipment or hospital-building emergency
6. Ask a biomedical or electrical person to visit your hospital (with the approval of your supervisor) and place a checked-tag on the equipment. The tag is to include information on the next check-up date and voltage use recommendations
7. Keep a list of other departments in the hospital (or nearby hospitals) who have similar equipment that you could borrow or contact for equipment advice should you need.
  - a. If you borrow equipment from another department, always check and test the equipment before use and make sure you are familiar with how to operate it.
8. Understand the hospital's administrative policies and procedures for requesting outside vendor service, and for procuring spare parts and accessories
9. Understand any national, regional regulations, and guidelines and standards applicable to operation of medical equipment within the hospital facility (compressed gases, electrical, fire, etc.)

## References

Orbis *Guide to Ophthalmic Equipment* (2004) Orbis International

OSHA (2002) *Occupational Safety and Health Administration: OSHA-3075 Controlling Electrical Hazards*.



## Assessment Activity 2

Now that you have completed this module you are ready to start caring for the equipment in your department. Complete the activity below, with the permission of your supervisor, and write a summary of your experiences, and send the summary to your Orbis Mentor.

Activity:

With your supervisor's permission, work on your own or as a nursing team to re-design how you use and care for your equipment. You are required to:

1. Tidy the equipment storage areas
2. Log all equipment in the room/s
3. Identify which equipment items are working
4. Identify which equipment items are not working and remove them from service. Ask your supervisor to contact the biomedical engineering department for follow-up
5. Explore dust cover options for your equipment
6. Walk through your department looking at wall sockets. If you find that any are hanging out from the wall, have exposed wires or are not working, please inform your supervisor so that they can contact the electrical department for follow-up
7. Find out about the cleaning requirements of equipment in your area and clean them accordingly. You may need to read the manual, ask the doctor or ask the biomedical engineer for advice
8. Put together a nursing team cleaning roster to ensure the team is cleaning the equipment every day. Perhaps you want to take it in turns each day, each week or appoint one person who you know will do a good job
9. Find out if your hospital carries the spare bulbs, batteries, fuses or cords needed for your equipment to work. If not ask your supervisor if you can try and keep a stock in your department
10. Check your cylinder safety and follow-up or improve this safety if you need to
  - a. Perhaps you need to arrange a training session with your supervisor, doctor or biomedical engineering team to teach your nursing colleagues how to change and care for cylinders
11. Check that you are storing, cleaning, discarding and using your accessory items correctly and follow-up or improve this process if you need to
12. Discuss with your supervisor about developing regular nursing equipment checking, e.g. monthly, 3 or 6 monthly. This will promptly identify broken equipment and ensure they are fixed more quickly.

This activity may take you a few weeks to complete and may involve regular discussion with your supervisor, the department doctor and the biomedical engineering team. At the end of the process, write a summary of what you did in your re-design, the results and the long-term plan you have in place. Please submit this to your Orbis Mentor.

*If this task proved difficult to coordinate in the hospital you work in, write this in your summary. Your Orbis Mentor will not grade you down because of this but you will need to write down what happened so we can see that you attempted to complete the activity.*

### Activity Two Grade

	Possible Grade	Your Grade (completed by your Mentor)
Designed a safe work area	25	
Designed a long term equipment care process	25	
	50	

# Module 3: A Nurses Guide to Basic Anatomy and Physiology of the Eye ©

## Module Outline

This Module Includes:

### *Outside the eye*

- ◆ Bones: orbit
- ◆ Blinking and protection: eye lids
- ◆ Tears: lacrimal apparatus
- ◆ Movement: extra-ocular muscles

### *The Eye*

- ◆ The parts you can see at the front of the eye:
  - Conjunctiva
  - Cornea
  - Pupil
- ◆ The white part: Sclera
- ◆ Inside the eye
  - Sections of the inner eye
  - Iris
  - Lens
  - Aqueous humor
  - Uveal tract
  - Vitreous humor
  - Retina
  - Choroid
- ◆ Keeping Intraocular Pressure
- ◆ Messages to and from the brain
  - Optic Discs
  - Brain pathway

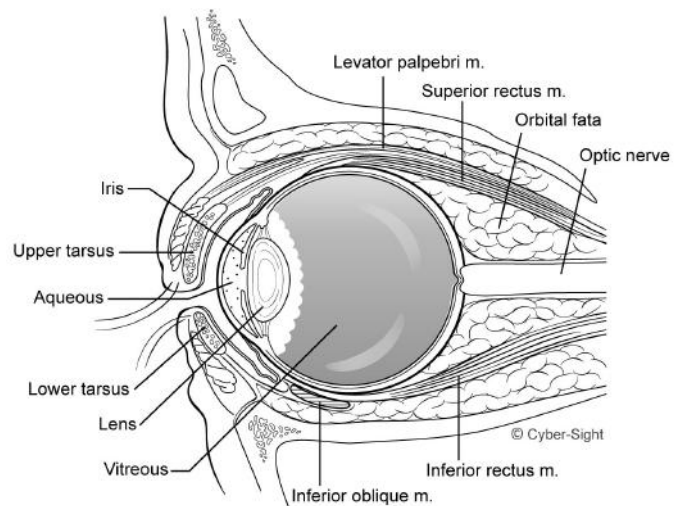
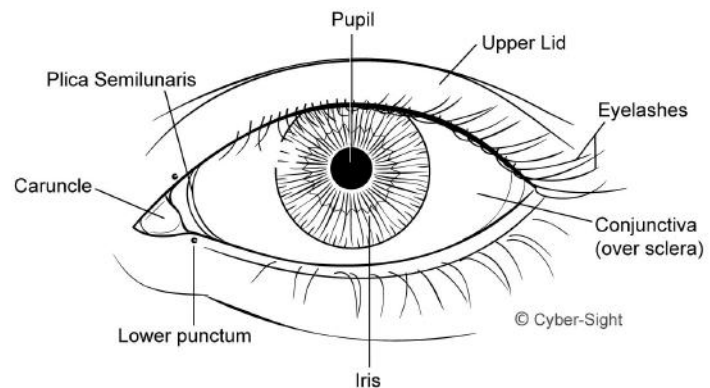

## Module Objectives

- ◆ Identify the anatomy of the normal eye
- ◆ Describe the physiology of the normal eye

*Note: This module has been designed for nurses who are new to ophthalmology (eye) nursing.*

If you are an experienced ophthalmic nurse, you may wish to visit Orbis's Cyber-Sight, [www.cybersight.org](http://www.cybersight.org). This site can provide you with alternative anatomy and physiology resources containing in-depth sub-specialty anatomy and physiology information. You may still complete the assessment activity at the end of this module for certification.

### **Why learn about A&P of the eye?**

Developing knowledge of ophthalmic anatomy and physiology (A&P) will assist you with understanding the function of the eye, congenital ocular disorders, ocular disease, prevention, treatment and day-to-day nursing application.

This will also assist you, during your day-to-day ophthalmic nursing work, when preparing a patient, conducting care management, assisting the surgeon in the operating room, providing patient education and helping to train your co-workers.

This module explores A&P and then links this knowledge to common ocular conditions you may come across in your healthcare facility.

## Bones: Orbit

The orbit is the bony cavity that surrounds the eye, providing a safe area for the soft eye to sit. The Orbit is constructed of seven (7) bones called the: Frontal, Maxillary, Zygomatic, Sphenoid, Ethmoid, Lacrimal and Palatine.

The orbit, which is shaped like a pear has a small hole at the back so that the optic nerve can enter and send visual messages to and from the brain. The volume of an adult orbit is approximately 30 mls (1 ounce). As the eye only takes up 1/3 of the space, there is also enough space in the orbit to hold fat, blood vessels, nerves, lacrimal apparatus and extra-ocular muscles.

The orbital rim is made up of stout bones that can protect the eye.

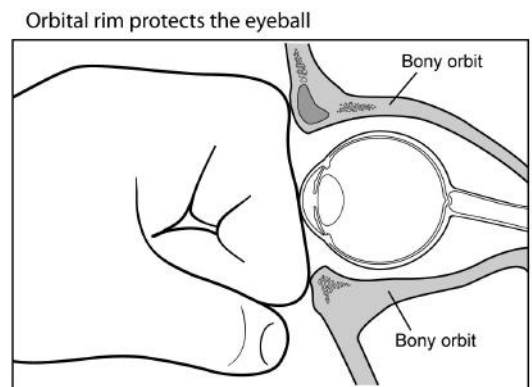
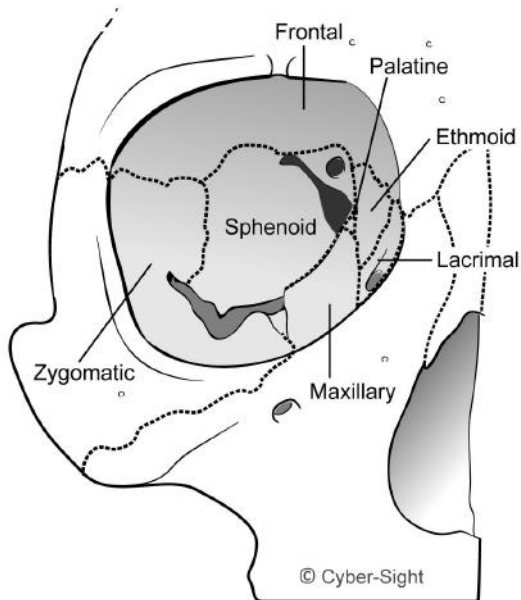

## Blinking and Protection: Eyelids

Eyelids are moveable folds of tissue and skin which cover and protect the eye. They keep the light out of the eye when the lids are closed. They also help lubricate the surface of the eye by opening and closing continually.

The eyelids consist of three layers:

1. The outer layer which is skin.
2. The middle layer which is made of connective tissue. This gives the eyelids their shape. This layer includes the Tarsal plate and the muscles that give the eyelids the ability to move
3. The third inner layer of the eyelid is a conjunctiva.

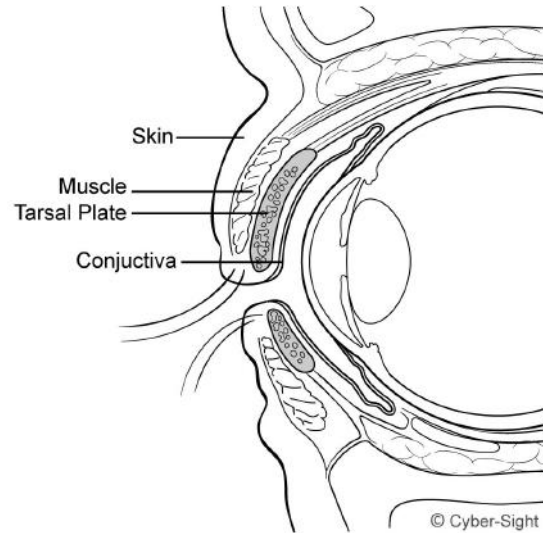

The eyelids contain eyelashes, called cilia, which help protect the surface of the eye when the eyes blink.

Goblet cells in the conjunctiva produce mucin to help stabilize the tear film that lubricates and helps protect the front of the eye. Glandular cells can also be identified. These are Meibomian in the tarsus that are sebaceous producing a fatty material. Other accessory lacrimal glands are found in front of and behind the lashes, Zeis and Moll, and in the conjunctiva, Krause and Wolfring. Watery tears are produced by the lacrimal gland.

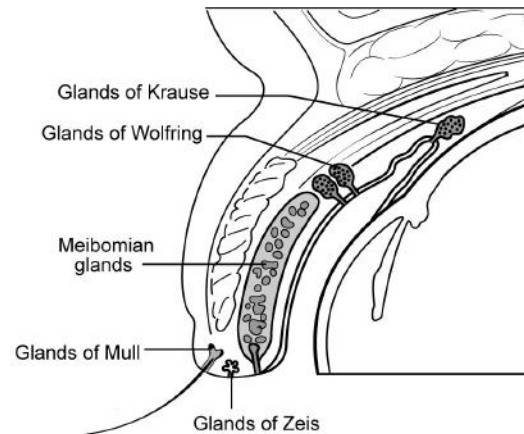

## Tears: Lacrimal System

Most people believe that tears are made from the corner of our eye, right next to the nose. This is, in fact, not true. Tears are actually produced in a small gland called the Lacrimal Gland located above and just lateral to the eye. This produces the tears which then trickle through ducts, until they reach the surface of the eye.

Watery tears are made more effective as a lubricant with help from the *Glands of Moll* and the *Glands of Krause and Wolfring*. The *Meibomian Gland* also helps by producing an oily sebaceous substance suitable for the lubricating and protecting the surface of the eye.

Once the tears reach the eye, they will be pushed across the eye due to the opening and closing of the eyelids. The tears move across the front of the eye and towards two drainage holes next to the nose called the Lacrimal Puncta, and then onwards into the Lacrimal Sac (the part where everyone thinks tears come from).

The reason tears move across the eye and accumulate in this area is because the only way the tears can be washed away from the eye is via the lacrimal puncta. The tears are drained into the sac and out through the throat, and swallowed. The lacrimal apparatus (system) performs this function every time we blink.

### Module Activity (not assessment)

Follow the tear Lacrimal Apparatus (system) and tear pathway below:

Lacrimal gland – lacrimal puncta – lacrimal canaliculi – lacrimal sac – lacrimal duct, into nose.

Draw arrows indicating the direction of the tears flow from production onwards.

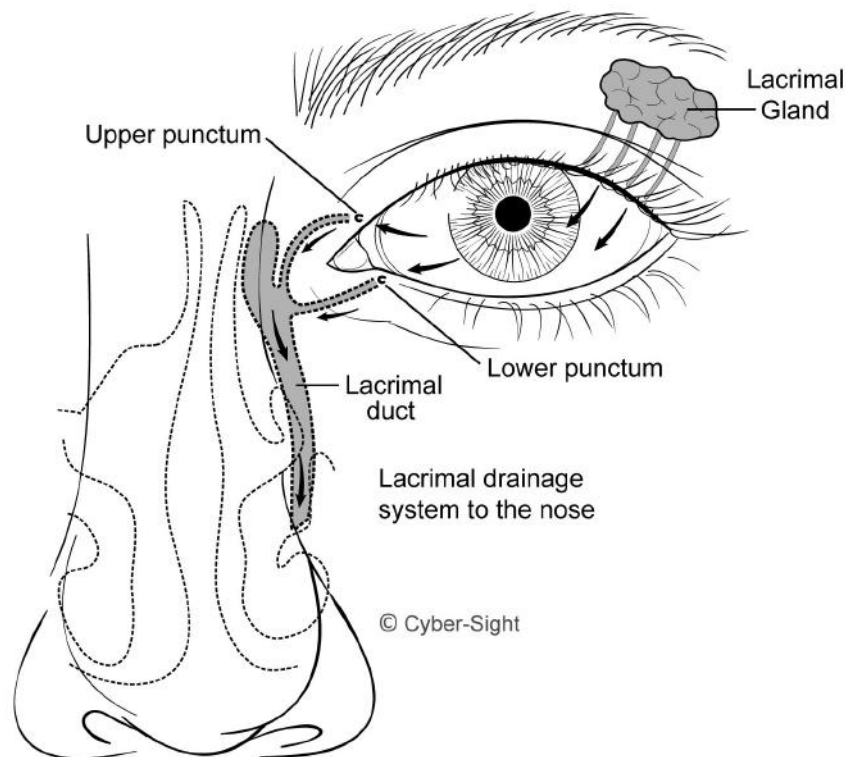

### Fun Facts

When we cry, we overproduce tears. The lacrimal duct can not wash away the tears quickly enough so the tears end up trickling out from the eye and down our cheek. This is why many people believe tears are produced at the corner of the lacrimal puncta.

Infants do not make watery tears until they are 4 to 6 months old. Mothers are frequently concerned when infants cry at this age, but no tears spill. They should be reassured. If there are no watery tears after 6 months of age, the infant should be checked.

## Movement: Extra-ocular Muscles

The eye can move in a variety of directions. This enables us to follow a moving object, fixate, and provide eye contact. To do this, the eye uses its six muscles to control the movement of the eyeball. These are referred to as the extra-ocular muscles and are called:

1. Medial Rectus: Rotates the eye towards the nose. This movement is known as adduction
2. Lateral Rectus: Rotates the eye outwards towards the temple. This movement is known as abduction
3. Superior Rectus: Turns the eye upwards
4. Inferior Rectus: Turns the eye downwards
5. Superior Oblique: Turns the eye downward and rotates it inward
6. Inferior Oblique: Turns the eye upward and rotates it outward

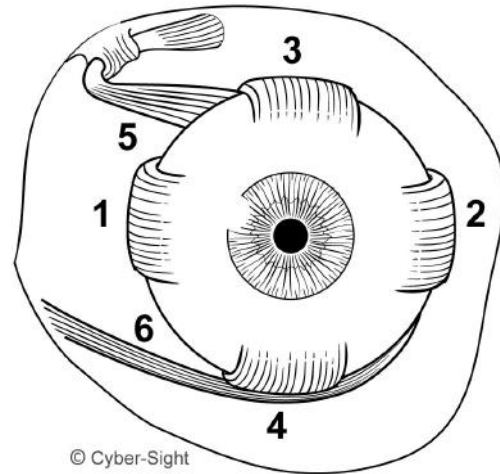

The ocular system is very sophisticated, making sure that the eyes are in alignment. When the left eye looks down, the right eye will also look down. This binocular process is controlled by a partnership between the visual system, the eye muscles, and the brain. *This unique partnership will be explored later in this module.*

## The Eye

### ***The Conjunctiva***

The conjunctiva is a transparent (clear) mucous membrane lining the inner surface of the eyelid and covering the anterior globe and extending to the limbus (circle representing the edge of the cornea).

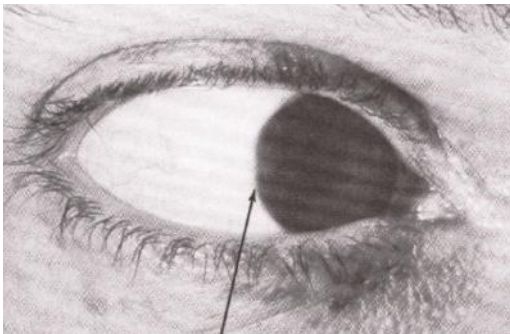

A The conjunctiva with the eye looking in has no special features other than fine imbedded blood vessels

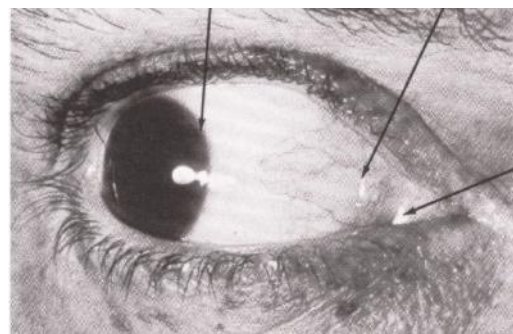

B The conjunctiva with the eye looking out shows in the medial aspect a small mound called the caruncle and next to that a fold of tissue called the plica semilunaris (third eye lid or nictitating membrane).

You can not see the conjunctiva as a distinct structure without special magnification lenses but it is there and is designed to:

1. Provide ease of movement for the eyelids as they move over the eye. It's slippery nature, combined with tear film, helps the eyelids to slide easily against the outer surface of the eyeball without causing damages
2. Produce mucin and aqueous layers of the tear film
3. Form a protective, nourished and oxygenated layer to the eye and the underlying tissue of the eyelid, via its network of tiny blood vessels.

### The Cornea

The cornea is located at the front of the eye, and extends to the sclera at the limbus. The cornea is clear and avascular (meaning no blood vessels) and allows light to enter the eye. The cornea is responsible for 70% of the refractive power (focusing light rays onto the retina) of the eye and is often referred to as the window of the eye.

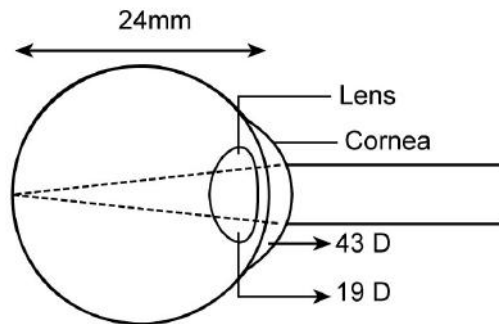

Stylized view of a cornea demonstrates the powerful focusing capability more than twice as much as the lens.

The cornea consists of 5 layers. Starting from the outside of the eye to the inside of the eye, these layers are the:

1. Corneal Epithelium: Acts as a barrier to the infection entering the eye. It can also regenerate with minimal scarring. It contains nerve ending that when exposed as with an abrasion cause severe pain and photophobia (intolerance to light).
2. Bowman's membrane - thin layer of collagen fibers
3. Stroma: Accounting for 90% of corneal thickness
4. Descemet's Membrane: Elastic fibers
5. Endothelium: It is very thin because it only has one layer of cells. It does not regenerate.

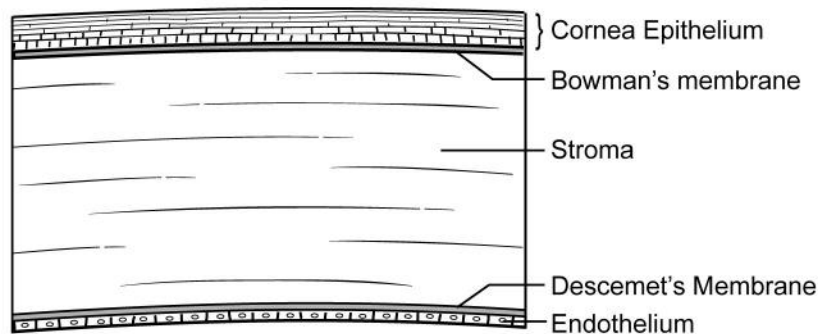

© Cyber-Sight

## ***The Center and Front of the Eye:***

### ***Pupil***

The pupil is the central opening of the iris. It changes size becoming smaller with bright light and larger in dim light or when the person is threatened. The pupil diameter may be as small as 2 mm and as large as 8 to 10 mm.

### ***The Lens***

The sole function of the lens is to focus light on the retina.

The lens is comprised of 3 layers.

1. An outer elastic capsule. The elasticity of the lens capsule allows the lens to change shape for accommodation
2. The (soft) cortex
3. The nucleus, the firm centre

With ageing, the lens becomes larger, denser and less flexible.

The lens absorbs nutrients and excretes waste products from the surrounding aqueous humor through the lens capsule and it is held in place by the suspensory ligaments attached to the ciliary body.

The ciliary muscles relax and contract changing the diameter and thickness of the lens to change the refractive power of the lens. This is known as accommodation and it enables near objects to be in focus. Humans lose the power to accommodate as they grow older. Most people require reading glasses starting between ages 40 and 50.

The lens is responsible for 30% of the refractive power of the eye; the cornea has the other 70% of the refractive power of the eye, but has no power of accommodation.

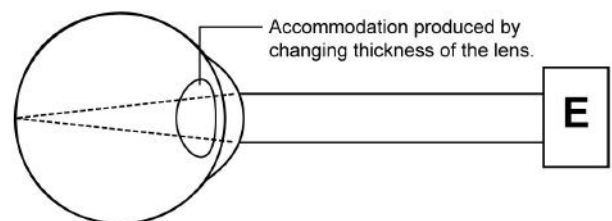
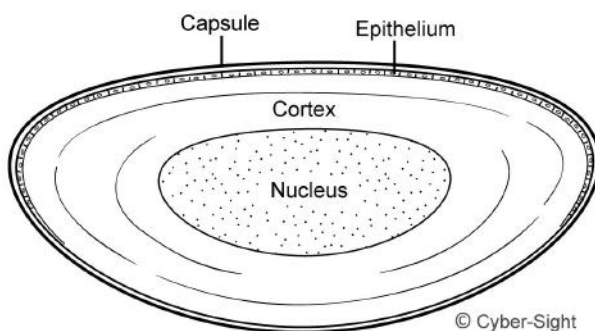

## ***The Uveal Tract***

The uveal tract consists of the Iris, the Ciliary body and the Choroid.

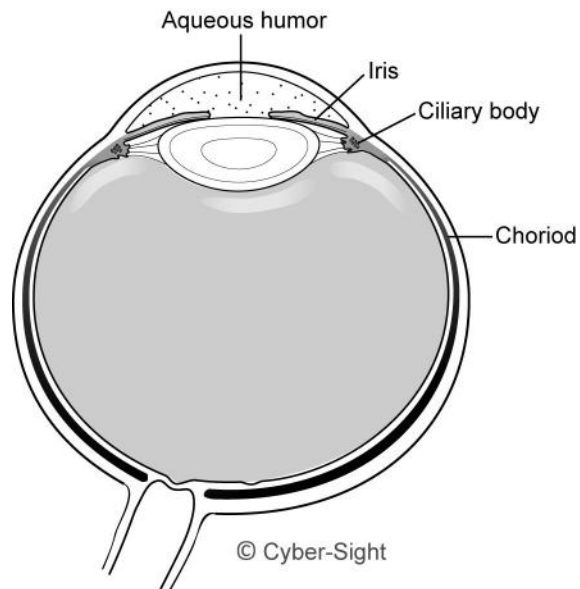

### ***Characteristics of the Uveal tract apparatus include:***

- ♦ Iris: A flat muscular tissue, radial and circular, that rests in front of the lens. The iris controls the amount of light entering the eye by changing the size of the pupil.
- ♦ Ciliary body: Made up of the ciliary muscles, the pars plicata and the pars plana and has 3 main functions
  - o Ciliary body produces aqueous humor for the avascular cornea and lens
  - o Ciliary body applies traction on the Trabecular meshwork, which opens to allow the outflow of aqueous humor
  - o Ciliary muscle assists in accommodation (assisting the eye to focus on near and far objects)
- ♦ Choroid is continuous with the ciliary body and lies between the sclera and the retina and provides nutrition to the retina.

## ***Aqueous Humor***

Aqueous humor is a clear fluid that fills the anterior segment (the anterior chamber and the posterior chamber) of the eye.

The aqueous humor has 3 main functions

1. To maintain the normal intraocular pressure (a range of 10-20 mmHg in an adult)
2. To provide nutrition to the avascular structures of the cornea and the lens
3. To act as a clear medium through which light may pass to the retina.

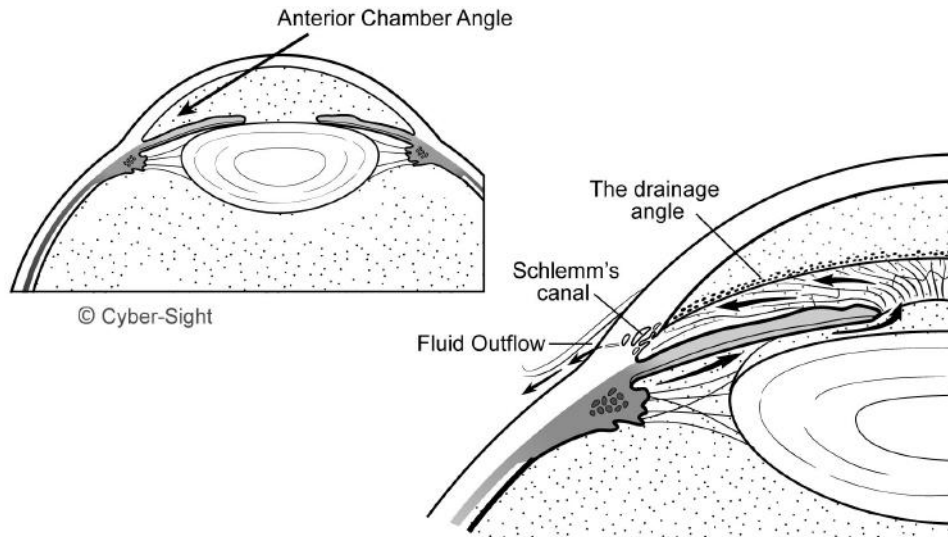

## **The Layers of the Eye: *Sclera, Choroid and Retina, and Vitreous***

### ***White Part of the Eye: Sclera***

The sclera is the white, dense, fibrous layer of the eye that is continuous around the outer layer of the eye. A section of the sclera can be seen from the front of an eye and is often referred to as the “white part”. The sclera forms a rigid and protective structure for the intraocular contents and meets with the cornea at the front of the eye at a point called the Limbus.

Externally, the ocular-muscles attach onto the sclera to help move the eye around. The slightly moveable conjunctiva rests on its surface at the front of the eye.

Internally, by keeping shape and size, the sclera supports the nourishing blood layer of the inner eye, known as the Choroid and helps ensure the intraocular pressure remains constant. We will discuss intraocular pressure later in another module.

## Choroid

The choroid is a highly vascular layer between the sclera and the retina. It provides nourishment to the retina.

## The Retina

The retina is the semi-transparent layer that covers the inner 2/3 of the eye. The retina consists of 9 layers of nerves and fibers and is responsible for the transfer of light impulses to the brain via the optic nerve.

At the back of the retina, there is a point called the Macula which is the area of the retina that is responsible for central vision.

The center of the macula is called the Fovea which is responsible for the most precise vision.

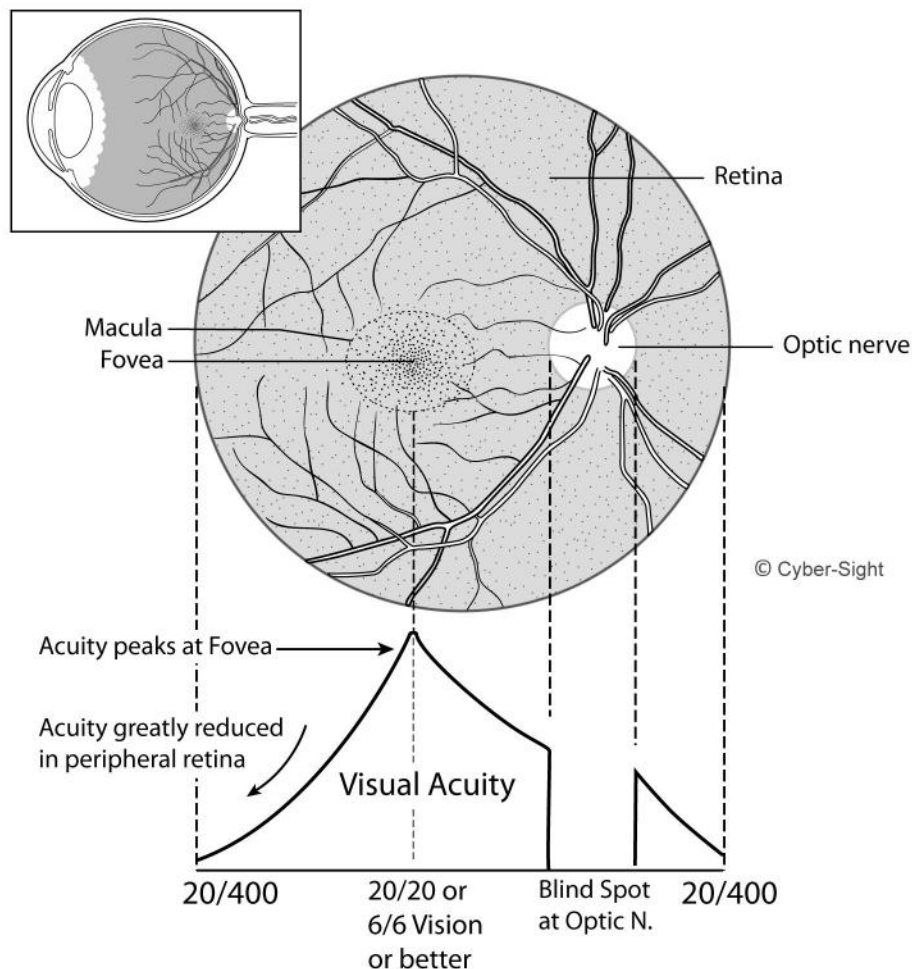
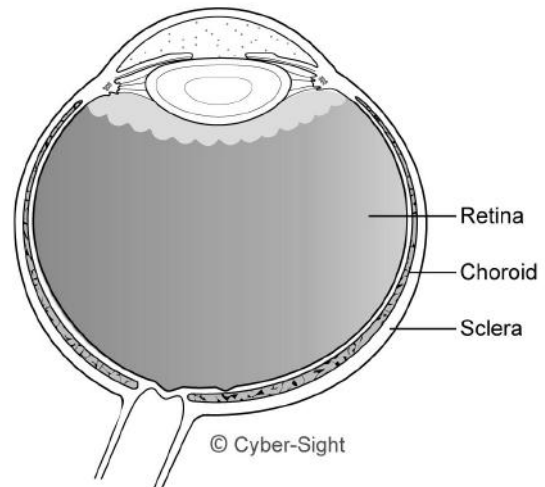

## ***The Vitreous Humor***

The vitreous is comprised of 99% water, and makes up 2/3 of the volume and weight of the eye. The vitreous humor is a clear avascular gel-like substance that fills the posterior segment of the eye (the cavity behind the lens to the retina).

The functions of the vitreous is to maintain the:

1. Transparency of the visual pathway
2. Structure and shape of the eye

Aqueous is a watery fluid constantly being formed and drained and maintaining a pressure around 15 mmHg. Vitreous is a crystal clear, highly viscous material that does not regenerate. It is highly viscous in youth and gradually becomes thinner with age.

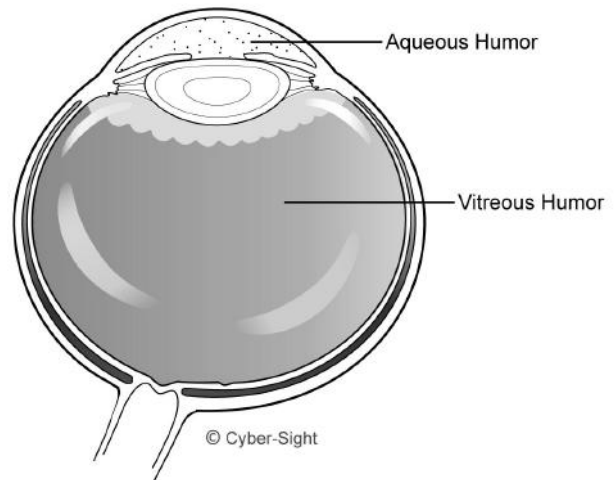

## **References**

Jack J. Kanski *Clinical Ophthalmology (4th Edition)* Butterworth Heinemann

Marsden, J., (2006) *Ophthalmic Care*, West Sussex, Wiley



## Assessment Activity 1

### Questionnaire

1. Name the 5 layers of the cornea?
  - a.
  - b.
  - c.
  - d.
  - e.
2. True or false, the Fovea is located in the cornea? T / F
3. What is the function of the trabecular mesh work?
4. True or false, the conjunctiva sits at the front surface of the eye, covering the sclera? T / F
5. What content is housed within the orbit?
6. What is the function of the lens? What would happen if this lens became cloudy?
7. The ocular muscle responsible for turning the eye inwards and downwards, towards the nose is: \_\_\_\_\_
8. What is accommodation and what does this accomplish?
9. True or false, the ciliary body is part of the uveal tract? T / F
10. What is the function of the uveal tract?

### Activity One Grade

	Possible Grade	Your Grade (completed by your Mentor)
Answers to questions	10 points per question	
	100	



## Nursing Registration Form

To receive a certificate at the completion of this module, please register by completing the below registration form and then send it to: nursingeducation@orbis.org).

To pass and receive an Orbis Certificate you must achieve a total 60% combined grade. On Registration, you will be contacted to provide you with the name and contact details of your Orbis Nurse Mentor. This is the person who can assist you with any learning questions, complete your grading, and provide you with a certificate of completion.

Please complete the below in English and write neatly.

Name: \_\_\_\_\_

Name of Hospital: \_\_\_\_\_

Address of Hospital you work at: \_\_\_\_\_

\_\_\_\_\_

Department that you work in at the hospital: \_\_\_\_\_

How long have you been a nurse: \_\_\_\_\_

Your preference mailing address for correspondance and sending of the certificate:

\_\_\_\_\_

\_\_\_\_\_

Your Mobile/Cell Phone Number: \_\_\_\_\_

Your email address: \_\_\_\_\_

Your Skype address: \_\_\_\_\_

### Mentor To Complete this Section:

<b>Module 1</b>	Activity 1 Grade:	Activity 2 Grade:	Activity 3 Grade:	Activity 4 Grade:
	Activity 5 Grade:	Activity 6 Grade:	Activity 7 Grade:	<b>Total:</b>
<b>Module 2</b>	Activity 1 Grade:	Activity 2 Grade:		<b>Total:</b>
<b>Module 3</b>	Activity 1 Grade:			<b>Total:</b>

Mentor Comment:

\_\_\_\_\_

\_\_\_\_\_

\_\_\_\_\_

Student's Signature: \_\_\_\_\_ Date: \_\_\_\_\_

Mentor's Signature: \_\_\_\_\_ Date: \_\_\_\_\_



Copyright February 2012